





# UTENSILI CERAMICI CERÁMICA



Contenuti - Inserti ceramici	<b>D02</b>
Índice - Plaquitas de cerámica	
Inserti ceramici	<b>D03-07</b>
Plaquitas de cerámica	
Indice applicazioni	<b>D08-09</b>
Índice de aplicaciones	
Frese per inserti ceramici	<b>D10-15</b>
Fresas para plaquitas de cerámica	
Portautensili per esterni	<b>D16-33</b>
Portaherramientas	
Portautensili per interni	<b>D34-40</b>
Barras de mandrinar	
Portautensili ceramici PSC con staffa superiore	<b>D41-53</b>
PSC para plaquitas de cerámica con fijación por brida superior	

**Inserti ceramici**  
**Plaquetas de cerámica**

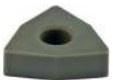
<p><b>CNGA</b></p>  <p>Pagina Página D03 0° <input type="checkbox"/></p>	<p><b>CNGN</b></p>  <p>Pagina Página D03 0° <input type="checkbox"/></p>	<p><b>CNGX</b></p>  <p>Pagina Página D03 0° <input type="checkbox"/></p>	<p><b>DNGA</b></p>  <p>Pagina Página D03 0° <input type="checkbox"/></p>	<p><b>DNGN</b></p>  <p>Pagina Página D03 0° <input type="checkbox"/></p>	<p><b>DNGX</b></p>  <p>Pagina Página D04 0° <input type="checkbox"/></p>
<p><b>ENGN</b></p>  <p>Pagina Página D04 0° <input type="checkbox"/></p>	<p><b>GWG</b></p>  <p>Pagina Página D04 3° <input checked="" type="checkbox"/></p>	<p><b>RCGX</b></p>  <p>Pagina Página D04 7° <input checked="" type="checkbox"/></p>	<p><b>RNGN</b></p>  <p>Pagina Página D04 0° <input type="checkbox"/></p>	<p><b>RPGN</b></p>  <p>Pagina Página D05 0° <input type="checkbox"/></p>	<p><b>SNGA</b></p>  <p>Pagina Página D05 0° <input type="checkbox"/></p>
<p><b>SNGN</b></p>  <p>Pagina Página D05 0° <input type="checkbox"/></p>	<p><b>SNGN</b></p>  <p>Pagina Página D05 0° <input type="checkbox"/></p>	<p><b>SNGX</b></p>  <p>Pagina Página D06 0° <input type="checkbox"/></p>	<p><b>TNGA</b></p>  <p>Pagina Página D06 0° <input type="checkbox"/></p>	<p><b>TNGN</b></p>  <p>Pagina Página D06 0° <input type="checkbox"/></p>	<p><b>VNGA</b></p>  <p>Pagina Página D07 0° <input type="checkbox"/></p>
<p><b>WNGA</b></p>  <p>Pagina Página D07 0° <input type="checkbox"/></p>					



## Inserti ceramici Plaquetas de cerámica

### Classificazione di uso

- Continuo
- ◐ Leggeramente interrotto
- ⊕ Interrotto

### Disponibilità

- Articolo standard
- Richiedere disponibilità

### Tipo de mecanizado

- Continuo
- ◐ Ligeramente interrumpido
- ⊕ Interrumpido

### Disponibilidad

- Artículo estándar
- Consulte disponibilidad

Materiale Material	Grado Calidad	● Continuo Continuo	◐ Leggeramente interrotto Ligeramente interrumpido	⊕ Interrotto Interrumpido
<b>K</b> Ghisa Fundición	CC2	●	◐	⊕
	CX6	●	◐	⊕
	CW1	●	◐	⊕
<b>S</b> Leghe resistenti al calore Aleaciones termorresistentes	CX9	●	◐	⊕
	CW1	●	◐	⊕
<b>H</b> Materiali induriti Materiales tratados	CC7	●	◐	⊕

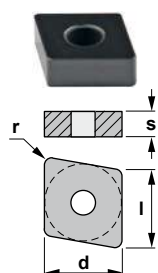

## CNGA

Inserto romboidale negativo 80°  
Plaqueta rómbica negativa 80°.

Riferimento / Referencia	l	s	d	r	CX6	CX9	CC2	CC7	CW1
CNGA 120404	12,90	4,76	12,70	0,4	●	◐	⊕	●	●
CNGA 120408	12,90	4,76	12,70	0,8	●	◐	⊕	●	●
CNGA 120412	12,90	4,76	12,70	1,2	●	◐	⊕	●	●

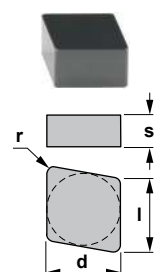

## CNGN

Inserto romboidale negativo 80°  
Plaqueta rómbica negativa 80°.

Riferimento / Referencia	l	s	d	r	CX6	CX9	CC2	CC7	CW1
CNGN 120408	12,90	4,76	12,70	0,8	●	◐	⊕	●	●
CNGN 120412	12,90	4,76	12,70	1,2	●	◐	⊕	●	●
CNGN 120708	12,90	7,94	12,70	0,8	●	◐	⊕	●	●
CNGN 120712	12,90	7,94	12,70	1,2	●	◐	⊕	●	●
CNGN 120716	12,90	7,94	12,70	1,6	●	◐	⊕	●	●

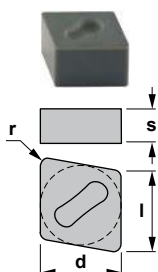

## CNGX

Inserto romboidale negativo 80°  
Plaqueta rómbica negativa 80°.

Riferimento / Referencia	l	s	d	r	CX6	CX9	CC2	CC7	CW1
CNGX 120708	12,90	7,94	12,70	0,8	●	◐	⊕	●	●
CNGX 120712	12,90	7,94	12,70	1,2	●	◐	⊕	●	●
CNGX 120716	12,90	7,94	12,70	1,6	●	◐	⊕	●	●
CNGX 160712	16,10	7,94	15,87	1,2	●	◐	⊕	●	●
CNGX 160716	16,10	7,94	15,87	1,6	●	◐	⊕	●	●

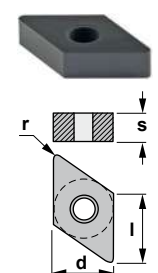

## DNGA

Inserto romboidale negativo 55°  
Plaqueta rómbica negativa 55°.

Riferimento / Referencia	l	s	d	r	CX6	CX9	CC2	CC7	CW1
DNGA 150404	15,50	4,76	12,70	0,4	●	◐	⊕	●	●
DNGA 150408	15,50	4,76	12,70	0,8	●	◐	⊕	●	●
DNGA 150412	15,50	4,76	12,70	1,2	●	◐	⊕	●	●

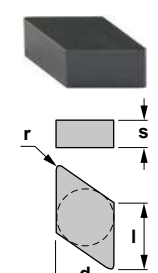

## DNGN

Inserto romboidale negativo 55°  
Plaqueta rómbica negativa 55°.

Riferimento / Referencia	l	s	d	r	CX6	CX9	CC2	CC7	CW1
DNGN 150708	15,50	7,94	12,70	0,8	●	◐	⊕	●	●
DNGN 150712	15,50	7,94	12,70	1,2	●	◐	⊕	●	●
DNGN 150716	15,50	7,94	12,70	1,6	●	◐	⊕	●	●

## Inserti ceramici Plaquetas de cerámica

### Classificazione di uso

- Continuo
- ◐ Leggeramente interrotto
- ⊕ Interrotto

### Disponibilità

- Articolo standard
- Richiedere disponibilità

### Tipo de mecanizado

- Continuo
- ◐ Ligeramente interrumpido
- ⊕ Interrumpido

### Disponibilidad

- Artículo estándar
- Consulte disponibilidad

Materiale Material		Grado Calidad	● Continuo Continuo	◐ Leggeramente interrotto Ligeramente interrumpido	⊕ Interrotto Interrumpido
<b>K</b>	Ghisa Fundición	CC2	●	◐	⊕
		CX6	●	◐	⊕
		CW1	●	◐	⊕
<b>S</b>	Leghe resistenti al calore Aleaciones termorresistentes	CX9	●	◐	⊕
		CW1	●	◐	⊕
<b>H</b>	Materiali induriti Materiales tratados	CC7	●	◐	⊕

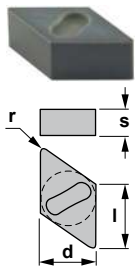

## DNGX

Inserto romboidale negativo 55°.  
Plaqueta rómbica negativa 55°.

Riferimento / Referencia	l	s	d	r	CX6	CX9	CC2	CC7	CW1
DNGX 120708	12,20	7,94	10,00	0,8	●				
DNGX 120712	12,20	7,94	10,00	1,2	●				
DNGX 120716	12,20	7,94	10,00	1,6	●				
DNGX 150708	15,50	7,94	12,70	0,8	●				
DNGX 150712	15,50	7,94	12,70	1,2	●	●			
DNGX 150716	15,50	7,94	12,70	1,6	●	●			

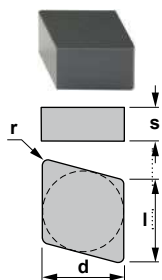

## ENGN

Inserto romboidale negativo 75°.  
Plaqueta rómbica negativa 75°.

Riferimento / Referencia	l	s	d	r	CX6	CX9	CC2	CC7	CW1
ENGN 130708	13,15	7,94	12,70	0,8			●		
ENGN 130712	13,15	7,94	12,70	1,2			●		
ENGN 130716	13,15	7,94	12,70	1,6			●		
ENGN 130720	13,15	7,94	12,70	2,0			●		

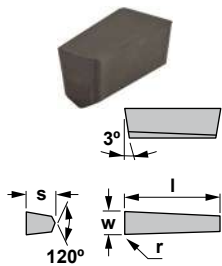

## GWG

Inserto positivo.  
Plaqueta positiva.

Riferimento / Referencia	l	s	w	r	CX6	CX9	CC2	CC7	CW1
GWG 04 M	12,00	5,00	4,00	0,5	○				
GWG 05 M	12,00	5,00	5,00	0,8	○				
GWG 06 M	15,00	7,50	6,00	0,8	○				
GWG 07	15,00	7,50	7,00	0,8	○				
GWG 08	15,00	7,50	8,00	0,8	○				
GWG 10	15,00	7,50	10,00	0,8	○				

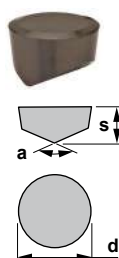

## RCGX

Inserto rotondo positivo.  
Plaqueta redonda positiva.

Riferimento / Referencia	s	d	a	CX6	CX9	CC2	CC7	CW1
RCGX 060700	7,94	6,35	120°		●	●		●
RCGX 090700	7,94	9,52	120°		●	●		●
RCGX 120700	7,94	12,70	120°		●	●		●
RCGX 151000	10,00	15,87	120°		●	●		●
RCGX 191000	10,00	19,05	120°		●	●		●
RCGX 251200	12,00	25,40	140°		●	●		●

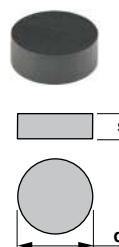

## RNGN

Inserto rotondo negativo.  
Plaqueta redonda negativa.

Riferimento / Referencia	s	d	CX6	CX9	CC2	CC7	CW1
RNGN 120400	4,76	12,70		●		●	●
RNGN 120700	7,94	12,70		●		●	●

## Inserti ceramici Plaquetas de cerámica

<b>i</b> <b>Classificazione di uso</b> ● Continuo ◐ Leggeramente interrotto ⊕ Interrotto		<b>i</b> <b>Tipo de mecanizado</b> ● Continuo ◐ Ligeramente interrumpido ⊕ Interrumpido		<b>Materiale</b> <b>Material</b>	<b>Grado</b> <b>Calidad</b>	● Continuo	◐ Leggeramente interrotto	⊕ Interrotto
<b>i</b> <b>Disponibilità</b> ● Articolo standard ○ Richiedere disponibilità		<b>i</b> <b>Disponibilidad</b> ● Artículo estándar ○ Consulte disponibilidad				● Continuo	◐ Leggeramente interrotto	⊕ Interrotto
<b>K</b>	Ghisa Fundición	CC2	●	●	●	●	●	
		CX6	●	●	●	●	●	
<b>S</b>	Leghe resistenti al calore Aleaciones termorresistentes	CW1	●	●	●	●	●	
		CX9	●	●	●	●	●	
<b>H</b>	Materiali induriti Materiales tratados	CW1	●	●	●	●	●	
		CC7	●	●	●	●	●	

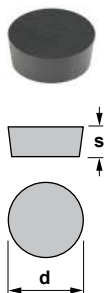

### RPGN

Inserto rotondo negativo.  
Plaqueta redonda negativa.

Riferimento / Referencia	s	d	CX6	CX9	CC2	CC7	CW1
RPGN 060200	2,38	6,35	●	●	●	●	●
RPGN 090300	3,18	9,52	●	●	●	●	●
RPGN 120400	4,76	12,70	●	●	●	●	●

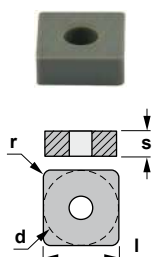

### SNGA

Inserto quadrato negativo.  
Plaqueta cuadrada negativa.

Riferimento / Referencia	l	s	d	r	CX6	CX9	CC2	CC7	CW1
SNGA 120408	12,70	4,76	12,70	0,8	●	●	●	●	●
SNGA 120412	12,70	4,76	12,70	1,2	●	●	●	●	●
SNGA 120416	12,70	4,76	12,70	1,6	●	●	●	●	●

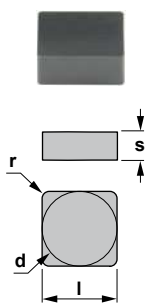

### SNGN

Inserto quadrato negativo.  
Plaqueta cuadrada negativa.

Riferimento / Referencia	l	s	d	r	CX6	CX9	CC2	CC7	CW1
SNGN 120404	12,70	4,76	12,70	0,4	●	●	●	●	●
SNGN 120408	12,70	4,76	12,70	0,8	●	●	●	●	●
SNGN 120412	12,70	4,76	12,70	1,2	●	●	●	●	●
SNGN 120416	12,70	4,76	12,70	1,6	●	●	●	●	●
SNGN 120420	12,70	4,76	12,70	2,0	●	○	○	○	○
SNGN 120424	12,70	4,76	12,70	2,4	●	○	○	○	○
SNGN 120708	12,70	7,94	12,70	0,8	●	●	●	●	●
SNGN 120712	12,70	7,94	12,70	1,2	●	●	●	●	●
SNGN 120716	12,70	7,94	12,70	1,6	●	●	●	●	●
SNGN 120720	12,70	7,94	12,70	2,0	●	○	○	○	○

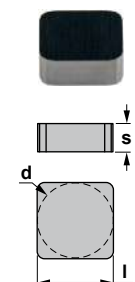

### SNGN

Inserto quadrato negativo.  
Plaqueta cuadrada negativa.

Riferimento / Referencia	l	s	d	CX6	CX9	CC2	CC7	CW1
SNGN 1204ENT	12,70	4,76	12,70	●	●	●	●	●



## Inserti ceramici Plaquetas de cerámica

### Classificazione di uso

- Continuo
- ◐ Leggeramente interrotto
- ⊕ Interrotto

### Disponibilità

- Articolo standard
- Richiedere disponibilità

### Tipo de mecanizado

- Continuo
- ◐ Ligeramente interrumpido
- ⊕ Interrumpido

### Disponibilidad

- Artículo estándar
- Consulte disponibilidad

Materiale Material	Grado Calidad	● Continuo Continuo	◐ Leggeramente interrotto Ligeramente interrumpido	⊕ Interrotto Interrumpido
<b>K</b> Ghisa Fundición	CC2	●	◐	⊕
	CX6	●	◐	⊕
	CW1	●	◐	⊕
<b>S</b> Leghe resistenti al calore Aleaciones termorresistentes	CX9	●	◐	⊕
	CW1	●	◐	⊕
<b>H</b> Materiali induriti Materiales tratados	CC7	●	◐	⊕

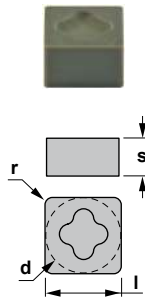

## SNGX

Inserto quadrato negativo.  
Plaqueta cuadrada negativa.

Riferimento / Referencia	l	s	d	r	CX6	CX9	CC2	CC7	CW1
SNGX 120708	12,70	7,94	12,70	0,8	●				
SNGX 120712	12,70	7,94	12,70	1,2	●				
SNGX 120716	12,70	7,94	12,70	1,6	●				
SNGX 150708	15,87	7,94	15,87	0,8	○				
SNGX 150712	15,87	7,94	15,87	1,2	●	●			
SNGX 150716	15,87	7,94	15,87	1,6	●	●			

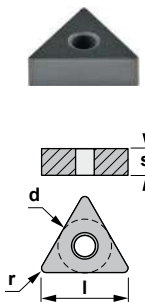

## TNGA

Inserto triangolare negativo.  
Plaqueta triangular negativa.

Riferimento / Referencia	l	s	d	r	CX6	CX9	CC2	CC7	CW1
TNGA 160404	16,50	4,76	9,52	0,4				●	
TNGA 160408	16,50	4,76	9,52	0,8				●	
TNGA 160412	16,50	4,76	9,52	1,2				●	
TNGA 160416	16,50	4,76	9,52	1,6				○	

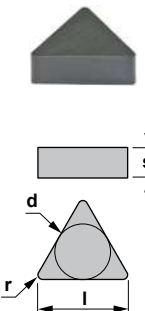

## TNGN

Inserto triangolare negativo.  
Plaqueta triangular negativa.

Riferimento / Referencia	l	s	d	r	CX6	CX9	CC2	CC7	CW1
TNGN 160408	16,50	4,76	9,52	0,8			●		
TNGN 160412	16,50	4,76	9,52	1,2			●		
TNGN 160416	16,50	4,76	9,52	1,6			●		
TNGN 160708	16,50	7,94	9,52	0,8			●		
TNGN 160712	16,50	7,94	9,52	1,2			○		

## Inserti ceramici Plaquetas de cerámica

<b>i</b> <b>Classificazione di uso</b> ● Continuo ● Leggeramente interrotto ✚ Interrotto		<b>i</b> <b>Tipo de mecanizado</b> ● Continuo ● Leggeramente interrotto ✚ Interrupido		<b>Materiale</b> <b>Material</b>	<b>Grado</b> <b>Calidad</b>	● Continuo	● Leggeramente interrotto	✚ Interrotto
<b>i</b> <b>Disponibilità</b> ● Articolo standard ○ Richiedere disponibilità		<b>i</b> <b>Disponibilidad</b> ● Artículo estándar ○ Consulte disponibilidad				● Continuo	● Leggeramente interrotto	✚ Interrotto
<b>K</b>	Ghisa Fundición	CC2	●	●	✚			
		CX6	●	●	✚	●	●	
		CW1	●	●	✚	●	●	
<b>S</b>	Leghe resistenti al calore Aleaciones termorresistentes	CX9	●	●	✚	●	●	
		CW1	●	●	✚	●	●	
<b>H</b>	Materiali induriti Materiales tratados	CC7	●	●	✚	●	●	

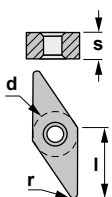

### VNGA

Inserto romboidale negativo 35°.  
Plaqueta rómbica negativa 35°.

Riferimento / Referencia	l	s	d	r	CX6	CX9	CC2	CC7	CW1
VNGA 160404	16,50	4,76	9,52	0,4				●	
VNGA 160408	16,50	4,76	9,52	0,8				●	
VNGA 160412	16,50	4,76	9,52	1,2				●	

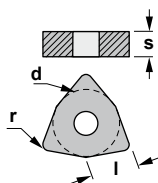
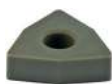

### WNGA

Inserto trigono negativo 80°.  
Plaqueta trigona negativa 80°.

Riferimento / Referencia	l	s	d	r	CX6	CX9	CC2	CC7	CW1
WNGA 080408	8,14	4,76	12,70	0,8	●			●	
WNGA 080412	8,14	4,76	12,70	1,2	●			●	



**Frese per inserti ceramici**  
**Fresas para plaquitas de cerámica**

**1242.90 88°**

Spallanti e spianatura 88°  
Escuadrado y planeado 88°

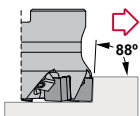

Pagina  
Página D10 SN.. 1204..

**1442.90 75°**

Spianatura 75°  
Planeado 75°

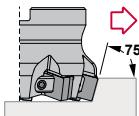

Pagina  
Página D11 SN.. 1204..

**5540.90**

Spianatura e copiatura  
Planeado y copiado

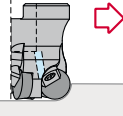

Pagina  
Página D12 RPGN 1204..

**5540.06**

Spianatura e copiatura  
Planeado y copiado

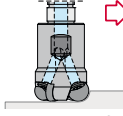

Pagina  
Página D13 RPGN 1204..

**5542.90**

Spianatura e copiatura  
Planeado y copiado

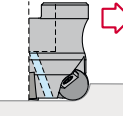

Pagina  
Página D14 RGN 1207..

**Portautensili per esterni**  
**Portaherramientas**

**CCBN 75°**

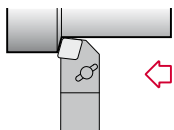

CNG.. 1204..  
CNG.. 1207..  
CNG.. 1607..  
Pagina  
Página D16

**CCKN 75°**

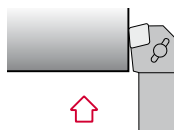

Pagina  
Página D17 CNG.. 1204..  
CNG.. 1207..

**CCLN 95°**

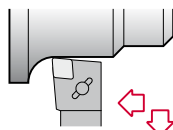

CNG.. 1204..  
CNG.. 1207..  
CNG.. 1607..  
Pagina  
Página D18

**CDJN 93°**

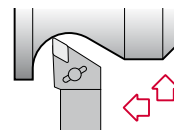

DNG.. 1204..  
DNG.. 1207..  
DNG.. 1507..  
Pagina  
Página D19

**CELN 97°30'**

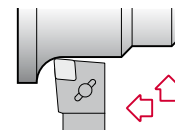

Pagina  
Página D20 ENGN 1307..

**CRDC**

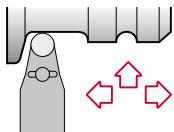

RCGX 0607..  
Pagina  
Página D21 RCGX 2512..

**CRDN**

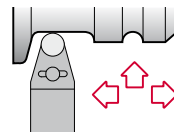

RNGN 1204..  
Pagina  
Página D22 RNGN 2507..

**CRSN**

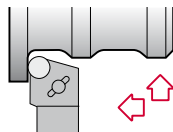

Pagina  
Página D23 RNGN 1204..  
RNGN 1207..

**CSDN 45°**

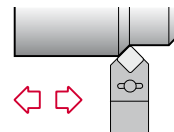

SNG.. 1204..  
SNG.. 1207..  
SNG.. 1507..  
Pagina  
Página D24

**CSKN 75°**

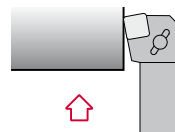

SNG.. 1204..  
SNG.. 1207..  
SNG.. 1507..  
Pagina  
Página D25

**CSRN 75°**

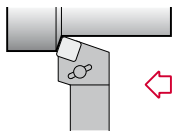

SNG.. 1204..  
SNG.. 1207..  
SNG.. 1507..  
Pagina  
Página D26

**CSSN 45°**

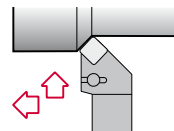

SNG.. 1204..  
SNG.. 1207..  
SNG.. 1507..  
Pagina  
Página D27

**CSXN 85°**

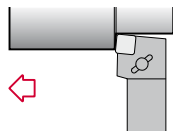

SNG.. 1204..  
SNG.. 1207..  
SNG.. 1507..  
Pagina  
Página D28

**CSYN 85°**

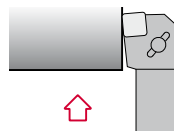

SNG.. 1204..  
SNG.. 1207..  
SNG.. 1507..  
Pagina  
Página D29

**CTFN 90°**

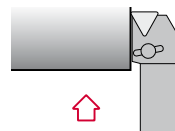

TNGN 1604..  
TNGN 1607..  
Pagina  
Página D30

**CTGN 90°**

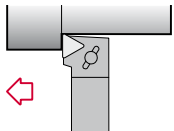

Pagina  
Página D31 TNGN 1604..  
TNGN 1607..

**CVJN 93°**

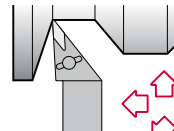

Pagina  
Página D32 VNG.. 1604..  
VNG.. 1607..

**CVVN 62°30'**

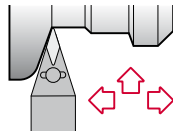

Pagina  
Página D33 VNG.. 1604..  
VNG.. 1607..

**Portautensili per interni**  
**Barras de mandrinar**

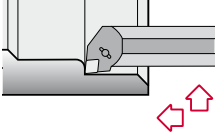
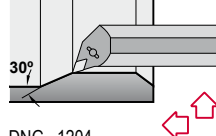
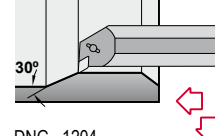
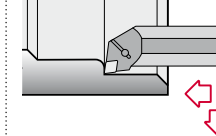
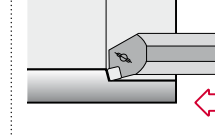
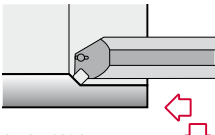
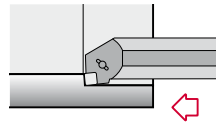
<p><b>CCLN 95°</b></p>  <p>Pagina CNG.. 1204..          Página D34 CNG.. 1207..</p>	<p><b>CDQN 107°30'</b></p>  <p>DNG.. 1204..          DNG.. 1507..</p> <p>Pagina Página D35</p>	<p><b>CDUN 93°</b></p>  <p>DNG.. 1204..          DNG.. 1507..</p> <p>Pagina Página D36</p>	<p><b>CELN 97°30'</b></p>  <p>Pagina Página D37 ENGN 1307..</p>	<p><b>CSKN 75°</b></p>  <p>Pagina SNG.. 1204..          Página D38 SNG.. 1207..</p>
<p><b>CSSN 45°</b></p>  <p>SNG.. 1204..          SNG.. 1207..          SNG.. 1507..</p> <p>Pagina Página D39</p>	<p><b>CSYN 85°</b></p>  <p>Pagina SNG.. 1204..          Página D40 SNG.. 1207..</p>			

**Portautensili ceramici PSC con staffa superiore**  
**PSC para plaquitas de cerámica con fijación por brida superior**

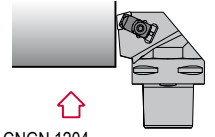
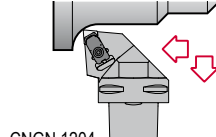
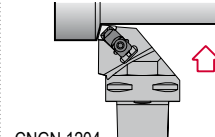
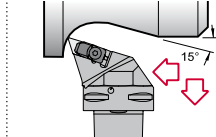
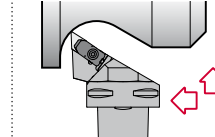
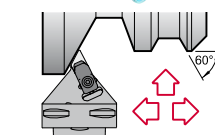
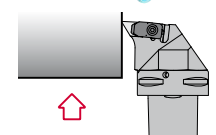
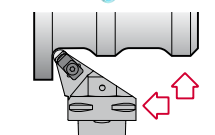
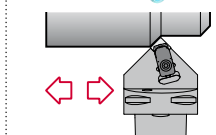
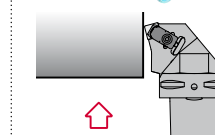
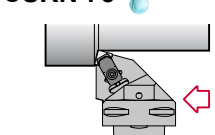
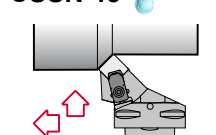
<p><b>CCKN 75°</b></p>  <p>CNGN 1204..          CNGN 1907..</p> <p>Pagina Página D42</p>	<p><b>CCLN 95°</b></p>  <p>CNGN 1204..          CNGN 1907..</p> <p>Pagina Página D43</p>	<p><b>CCRN 75°</b></p>  <p>CNGN 1204..          CNGN 1907..</p> <p>Pagina Página D44</p>	<p><b>CDHN 107°30'</b></p>  <p>Pagina Página D45 DNGN 1507..</p>	<p><b>CDJN 93°</b></p>  <p>Pagina Página D46 DNGN 1507..</p>
<p><b>CDNN 63°</b></p>  <p>DNGN 1507..</p> <p>Pagina Página D47</p>	<p><b>CDUN 93°</b></p>  <p>Pagina Página D48 DNGN 1507..</p>	<p><b>CRSN</b></p>  <p>Pagina RNGN 1204..          Página D49 RNGN 1207..</p>	<p><b>CSDN 45°</b></p>  <p>SNGN 1204..          SNGN 1207..</p> <p>Pagina Página D50</p>	<p><b>CSKN 75°</b></p>  <p>Pagina SNGN 1204..          Página D51 SNGN 1207..</p>
<p><b>CSRN 75°</b></p>  <p>Pagina SNGN 1204..          Página D52 SNGN 1207..</p>	<p><b>CSSN 45°</b></p>  <p>Pagina SNGN 1204..          Página D53 SNGN 1207..</p>			



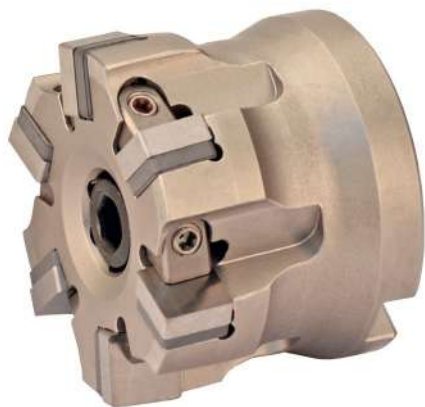

**Caratteristiche:**

Fresa negativa con angolo d'incidenza 88°. I robusti inserti permettono grande profondità di taglio e un'alto avanzamento per dente.

Prima scelta per la fresatura di ghisa.

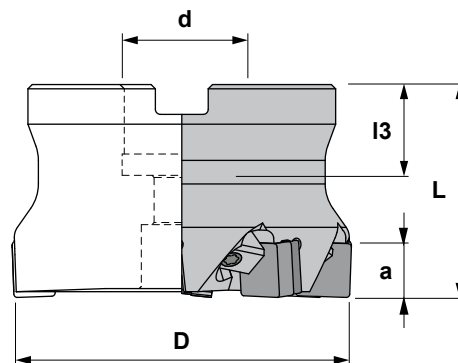

**Características:**

Fresa negativa con ángulo de incidencia de 88°. Sus robustas plaquitas permiten grandes profundidades de corte y un alto avance por diente.

Primera opción para el fresado de fundición.

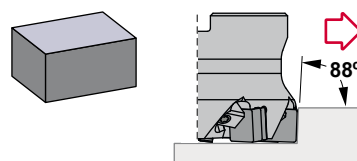

## 1242.90 88°

Riferimento Referencia		D	L	l3	a	d	Dimensioni inserto Medida plaquita	
1242.90.063	6	63	50	22	12	27	SN.. 1204..	0,980
1242.90.080	8	80	50	22	12	27	SN.. 1204..	1,240
1242.90.100	10	100	50	25	12	32	SN.. 1204..	1,920
1242.90.125	12	125	63	29	12	40	SN.. 1204..	3,360

Riferimento Referencia								Nm
1242.90.063	1630	3212	6226	1266	5515	-	912,10	3.0
1242.90.080	1630	3212	6226	1266	5515	-	912,12	3.0
1242.90.100	1630	3212	6226	1266	-	5615	912,16	3.0
1242.90.125	1630	3212	6226	1266	-	5615	-	3.0

### SN..

Inserti quadrati negativi. D05  
Plaquitas cuadradas negativas.

Riferimento / Ref.	l	s	d
SN.. 1204..	12,70	4,76	12,70

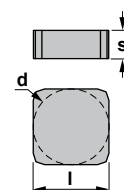

### SNGN



### SNGN





**Caratteristiche:**

Fresa negativa con angolo d'incidenza 75°. I robusti inserti permettono grande profondità di taglio e un'alto avanzamento per dente.

Prima scelta per la fresatura di ghisa.

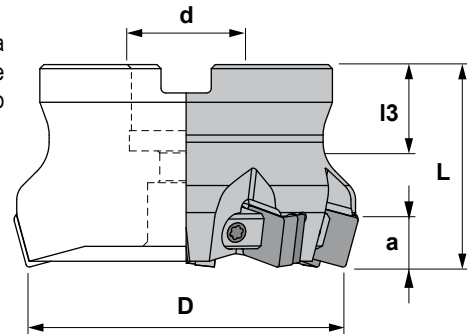

**Características:**

Fresa negativa con ángulo de incidencia de 75°. Sus robustas plaquitas permiten grandes profundidades de corte y un alto avance por diente.

Primera opción para el fresado de fundición.

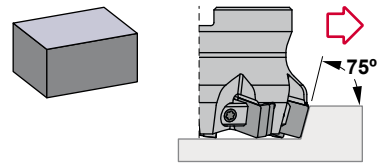

## 1442.90 75°

Riferimento Referencia		D	L	I3	a	d	Dimensioni inserto Medida plaquita	 Kg
1442.90.063	6	63	50	22	11	27	SN.. 1204..	0,980
1442.90.080	8	80	50	22	11	27	SN.. 1204..	1,240
1442.90.100	10	100	50	25	11	32	SN.. 1204..	1,920
1442.90.125	12	125	63	29	11	40	SN.. 1204..	3,360

Riferimento Referencia						Nm	
1442.90.063	1630	3212	6226	1266	5515	-	3.0
1442.90.080	1630	3212	6226	1266	5515	-	3.0
1442.90.100	1630	3212	6226	1266	-	5615	3.0
1442.90.125	1630	3212	6226	1266	-	5615	3.0

### SN..

Inserti quadrati negativi. D05  
Plaquitas cuadradas negativas.

Riferimento / Ref.	l	s	d
SN.. 1204..	12,70	4,76	12,70

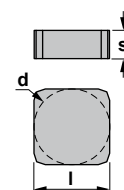

### SNGN



### SNGN





**Caratteristiche:**

Fresa ad inserti rotondi per fresatura di scanalature, fresatura periferica, lavorazione in rampa, foratura, fresature di tasche e copiatura.

Si può utilizzare in una sola passata (sgrossatura e finitura).

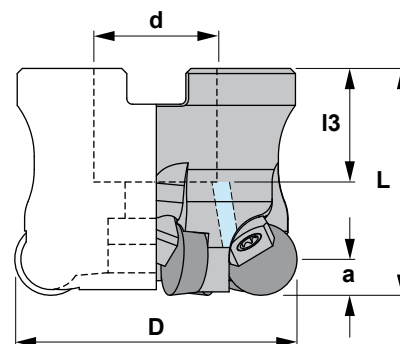

**Características:**

Fresa de plaquitas redondas para el fresado de ranuras, fresado periférico, fresado y taladrado en rampa, fresado de cajas y copiado.

Se puede utilizar en una sola pasada (desbaste y acabado).

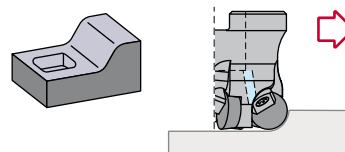

**5540.90**

Riferimento Referencia		D	L	l3	a	d	Dimensioni inserto Medida plaquita	
5540.90.040	4	40	40	18	6,35	16	RPGN 1204..	0,200
5540.90.050	5	50	40	20	6,35	22	RPGN 1204..	0,330

Riferimento Referencia					Nm
5540.90.040	1058	6226	1166	5515	3.0
5540.90.050	912,10	6226	1166	5515	3.0

**RPGN**

Inserto rotondo negativo. D05  
Plaquita redonda negativa.

Riferimento / Ref.	s	d
RPGN 1204..	4,76	12,70

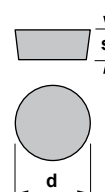



**Caratteristiche:**

Fresa modulare ad inserti rotondi per fresatura di scanalature, fresatura periferica, lavorazione in rampa, foratura, fresature di tasche e copiatura.  
Si può utilizzare in una sola passata (sgrossatura e finitura).

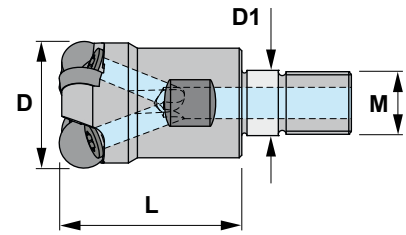

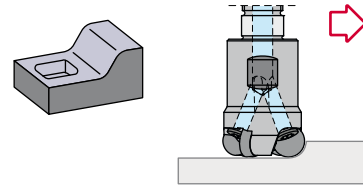

**Características:**

Fresa modular de plaquitas redondas para el fresado de ranuras, fresado periférico, fresado y taladrado en rampa, fresado de cajas y copiado.  
Se puede utilizar en una sola pasada (desbaste y acabado).



## 55<sup>2</sup><sub>4</sub>0.06

Riferimento Referencia		L	M	D	D1	Dimensioni inserto Medida plaquita	
5520.06.016	2	23	M8	16	8,5	RPGN 0602..	0,030
5520.06.020	3	30	M10	20	10,5	RPGN 0602..	0,060
5530.06.025	3	35	M12	25	12,5	RPGN 0903..	0,100
5530.06.032	4	43	M16	32	16,5	RPGN 0903..	0,210
5540.06.032	3	43	M16	32	16,5	RPGN 1204..	0,220

Riferimento Referencia			Nm
5520.06.016	1240	5515	3.0
5520.06.020	1240	5515	3.0
5530.06.025	1250	5520	4.0
5530.06.032	1250	5520	4.0
5540.06.032	1260	5525	5.0

### RPGN

Inserto rotondo negativo.  D05  
Plaquita redonda negativa.

Riferimento / Ref.	s	d
RPGN 0602..	2,38	6,35
RPGN 0903..	3,18	9,52
RPGN 1204..	4,76	12,70

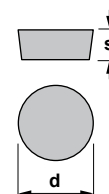



**Caratteristiche:**

Frese ad inserti rotondi negativi per fresatura di scanalature, fresatura periferica, lavorazione in rampa, foratura, fresature di tasche e copiatura.

Si può utilizzare in una sola passata (sgrossatura e finitura).

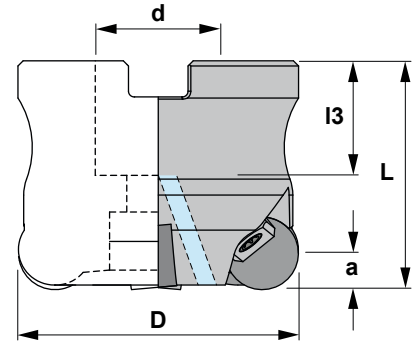

**Características:**

Fresa de plaquitas redondas para el fresado de ranuras, fresado periférico, fresado y taladrado en rampa, fresado de cajas y copiado.

Se puede utilizar en una sola pasada (desbaste y acabado).

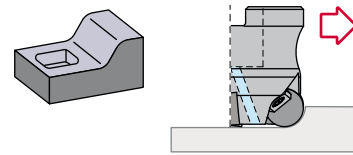

**5542.90**

Riferimento Referencia		D	L	l3	a	d	Dimensioni inserto Medida plaquita	
5542.90.050	4	50	40	20	6,35	22	RNGN 1207..	0,350
5542.90.063	5	63	50	20	6,35	22	RNGN 1207..	0,800
5542.90.080	6	80	50	22	6,35	27	RNGN 1207..	1,250

Riferimento Referencia					Nm
5542.90.050	912,10	6226	1166	5515	3.0
5542.90.063	912,10	6226	1266	5515	3.0
5542.90.080	912,12	6226	1266	5515	3.0

**RNGN**

Inserto rotondo negativo. D04  
Plaquita redonda negativa.

Riferimento / Ref.	s	d
RNGN 1207..	7,94	12,70

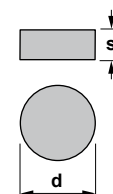



### **Frese per inserti ceramici**

*Gli inserti ceramici lavorano più velocemente dagli inserti in metallo duro. In questo modo c'è un incremento della produttività nella lavorazione ad alta temperatura.*

### **Fresas para plaquitas de cerámica**

*Las plaquitas cerámicas trabajan más rápidamente que las plaquitas de metal duro. De esta manera se incrementa la productividad en el mecanizado a altas temperaturas.*

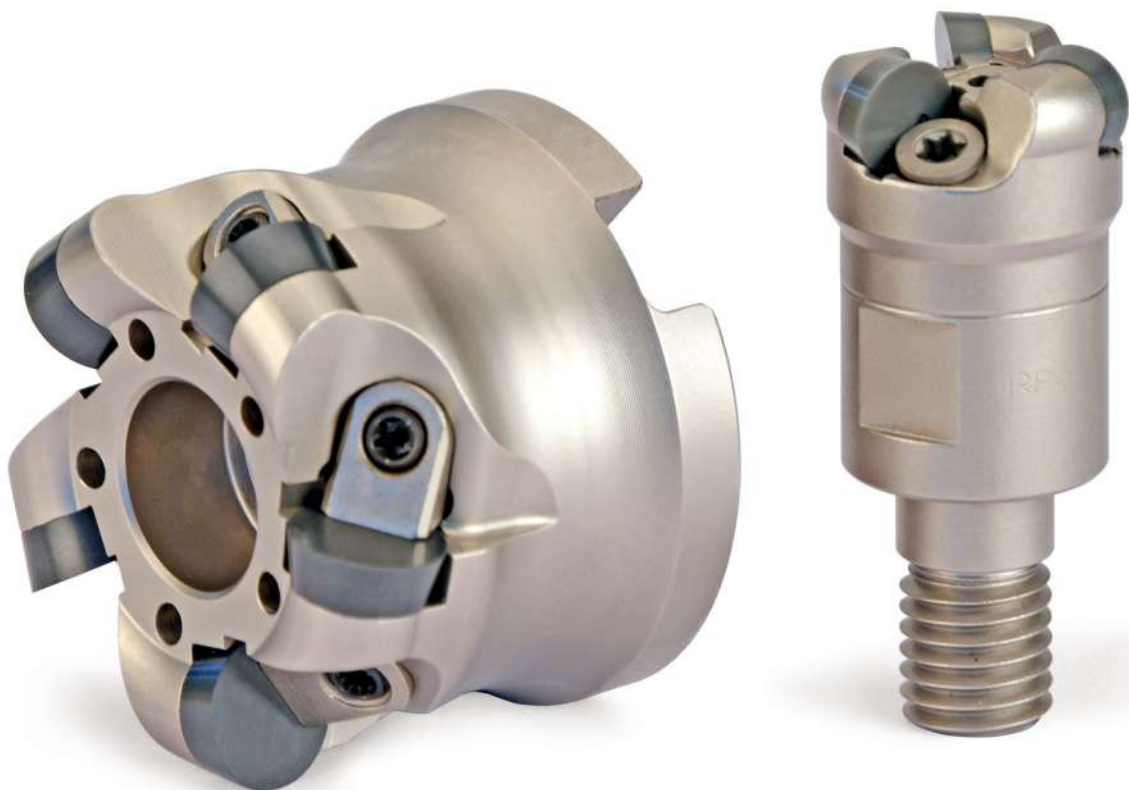



**Caratteristiche:**

Portautensili per operazioni di tornitura esterna, montano inserti romboidali negativi (angolo 80°).  
Per applicazioni generali, sgrossatura, semi-finitura e finitura.

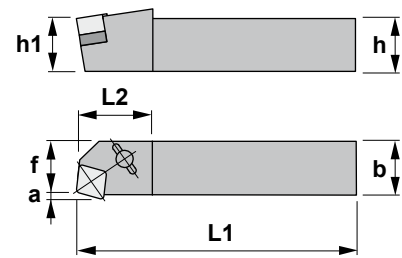

**Características:**

Portaherramientas para operaciones de torneado exterior equipado con plaquita rómbica negativa (ángulo 80°).  
Para aplicaciones generales, desbaste, semiacabados y acabados.

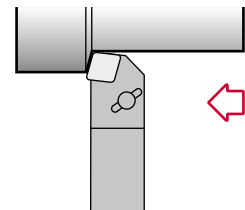

## CCBN 75°

Riferimento Referencia	h=h1	b	L1	L2	f	a	Dimensioni inserto Medida plaquita	Kg
CCBN R/L 2525 M12-4CD	25	25	150	34	22	3,10	CNGN 1204..	0,750
CCBN R/L 2525 M12-7CD	25	25	150	34	22	3,10	CNGN 1207..	0,750
CCBN R/L 3225 P12-4CD	32	25	170	34	22	3,10	CNGN 1204..	1,050
CCBN R/L 3225 P12-7CD	32	25	170	34	22	3,10	CNGN 1207..	1,050
CCBN R/L 2525 M16-CD	25	25	150	34	27	3,82	CNGN 1607..	0,750
CCBN R/L 3225 P16-CD	32	25	170	34	27	3,82	CNGN 1607..	1,050
CCBN R/L 2525 M12-4CX	25	25	150	34	22	3,10	CNGX 1204..	0,750
CCBN R/L 2525 M12-7CX	25	25	150	34	22	3,10	CNGX 1207..	0,750
CCBN R/L 3225 P12-4CX	32	25	170	34	22	3,10	CNGX 1204..	1,050
CCBN R/L 3225 P12-7CX	32	25	170	34	22	3,10	CNGX 1207..	1,050
CCBN R/L 2525 M16-CX	25	25	150	34	27	3,82	CNGX 1607..	0,750
CCBN R/L 3225 P16-CX	32	25	170	34	27	3,82	CNGX 1607..	1,050

Riferimento Referencia							Nm
CCBN R/L 2525 M12-4CD	ICSN 454	1160	9414	2417	-	5004	3.5
CCBN R/L 2525 M12-7CD	ICSN 434	1160	9414	2417	-	5004	3.5
CCBN R/L 3225 P12-4CD	ICSN 454	1160	9414	2417	-	5004	3.5
CCBN R/L 3225 P12-7CD	ICSN 434	1160	9414	2417	-	5004	3.5
CCBN R/L 2525 M16-CD	ICSN 533	1180	9414	2417	-	5004	3.5
CCBN R/L 3225 P16-CD	ICSN 533	1180	9414	2417	-	5004	3.5
CCBN R/L 2525 M12-4CX	ICSN 454	1160	-	-	2471	5004	3.5
CCBN R/L 2525 M12-7CX	ICSN 434	1160	-	-	2471	5004	3.5
CCBN R/L 3225 P12-4CX	ICSN 454	1160	-	-	2471	5004	3.5
CCBN R/L 3225 P12-7CX	ICSN 434	1160	-	-	2471	5004	3.5
CCBN R/L 2525 M16-CX	ICSN 533	1180	-	-	2415	5004	3.5
CCBN R/L 3225 P16-CX	ICSN 533	1180	-	-	2415	5004	3.5

### CNG..

Inserti romboidali negativi 80°.  
Plaquetas rómbicas negativas 80°.

D03

Riferimento / Ref.	l	s	d
CNG.. 1204..	12,90	4,76	12,70
CNG.. 1207..	12,90	7,94	12,70
CNG.. 1607..	16,10	7,94	15,88

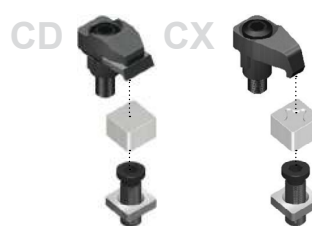
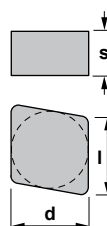

### CNGN



### CNGX





**Caratteristiche:**

Portautensili per operazioni esterne di sfacciatura, montano inserti romboidali negativi (angolo 80°).  
Per applicazioni generali, sgrassatura, semi-finitura e finitura.

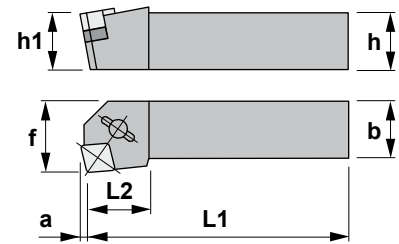

**Características:**

Portaherramientas para refrentar equipado con plaquita rómbica negativa (ángulo 80°).  
Para aplicaciones generales, desbaste, semiacabados y acabados.

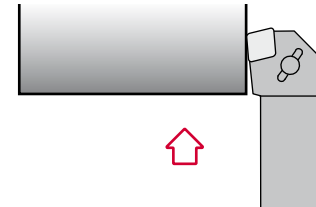

## CCKN 75°

Riferimento Referencia	h=h1	b	L1	L2	f	a	Dimensioni inserto Medida plaquita	Kg
CCKN R/L 2525 M12-4CD	25	25	150	29	32	3,10	CNGN 1204..	0,750
CCKN R/L 2525 M12-7CD	25	25	150	29	32	3,10	CNGN 1207..	0,750
CCKN R/L 3225 P12-4CD	32	25	170	29	32	3,10	CNGN 1204..	1,050
CCKN R/L 3225 P12-7CD	32	25	170	29	32	3,10	CNGN 1207..	1,050
CCKN R/L 2525 M12-4CX	25	25	150	29	32	3,10	CNGX 1204..	0,750
CCKN R/L 2525 M12-7CX	25	25	150	29	32	3,10	CNGX 1207..	0,750
CCKN R/L 3225 P12-4CX	32	25	170	29	32	3,10	CNGX 1204..	1,050
CCKN R/L 3225 P12-7CX	32	25	170	29	32	3,10	CNGX 1207..	1,050

Riferimento Referencia							Nm
CCKN R/L 2525 M12-4CD	ICSN 454	1160	9414	2417	-	5004	3.5
CCKN R/L 2525 M12-7CD	ICSN 434	1160	9414	2417	-	5004	3.5
CCKN R/L 3225 P12-4CD	ICSN 454	1160	9414	2417	-	5004	3.5
CCKN R/L 3225 P12-7CD	ICSN 434	1160	9414	2417	-	5004	3.5
CCKN R/L 2525 M12-4CX	ICSN 454	1160	-	-	2471	5004	3.5
CCKN R/L 2525 M12-7CX	ICSN 434	1160	-	-	2471	5004	3.5
CCKN R/L 3225 P12-4CX	ICSN 454	1160	-	-	2471	5004	3.5
CCKN R/L 3225 P12-7CX	ICSN 434	1160	-	-	2471	5004	3.5

### CNG..

Inserti romboidali negativi 80°.  
Plaquetas rómbicas negativas 80°. D03

Riferimento / Ref.	l	s	d
CNG.. 1204..	12,90	4,76	12,70
CNG.. 1207..	12,90	7,94	12,70

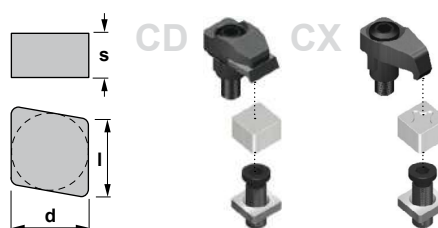

#### CNGN



#### CNGX





**Caratteristiche:**

Portautensili per molteplici operazioni di tornitura esterna, montano inserti romboidali negativi bifacciali (angolo 80°).

Per applicazioni generali, sgrossatura, semi-finitura e finitura.

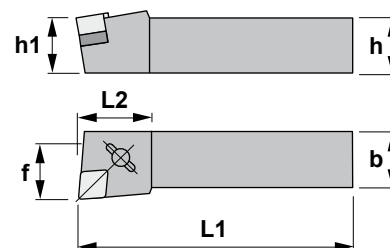

**Características:**

Portaherramientas multifunción equipado con plaquita rómbica negativa de doble cara (ángulo 80°).

Para aplicaciones generales, desbaste, semiacabados y acabados.

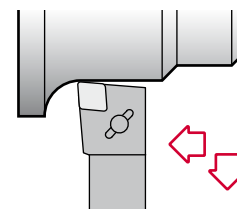

## CCLN 95°

Riferimento Referencia	h=h1	b	L1	L2	f	Dimensioni inserto Medida plaquita	⚖️ Kg
CCLN R/L 2525 M12-4CD	25	25	150	34	32	CNGN 1204..	0,750
CCLN R/L 2525 M12-7CD	25	25	150	34	32	CNGN 1207..	0,750
CCLN R/L 3225 P12-4CD	32	25	170	34	32	CNGN 1204..	1,050
CCLN R/L 3225 P12-7CD	32	25	170	34	32	CNGN 1207..	1,050
CCLN R/L 2525 M16-CD	25	25	150	34	32	CNGN 1607..	0,750
CCLN R/L 3225 P16-CD	32	25	170	38	32	CNGN 1607..	1,050
CCLN R/L 2525 M12-4CX	25	25	150	34	32	CNGX 1204..	0,750
CCLN R/L 2525 M12-7CX	25	25	150	34	32	CNGX 1207..	0,750
CCLN R/L 3225 P12-4CX	32	25	170	34	32	CNGX 1204..	1,050
CCLN R/L 3225 P12-7CX	32	25	170	34	32	CNGX 1207..	1,050
CCLN R/L 2525 M16-CX	25	25	150	34	32	CNGX 1607..	0,750
CCLN R/L 3225 P16-CX	32	25	170	38	32	CNGX 1607..	1,050

Riferimento Referencia							Nm
CCLN R/L 2525 M12-4CD	ICSN 454	1160	9414	2417	-	5004	3.5
CCLN R/L 2525 M12-7CD	ICSN 434	1160	9414	2417	-	5004	3.5
CCLN R/L 3225 P12-4CD	ICSN 454	1160	9414	2417	-	5004	3.5
CCLN R/L 3225 P12-7CD	ICSN 434	1160	9414	2417	-	5004	3.5
CCLN R/L 2525 M16-CD	ICSN 533	1180	9414	2417	-	5004	3.5
CCLN R/L 3225 P16-CD	ICSN 533	1180	9414	2417	-	5004	3.5
CCLN R/L 2525 M12-4CX	ICSN 454	1160	-	-	2415	5004	3.5
CCLN R/L 2525 M12-7CX	ICSN 434	1160	-	-	2415	5004	3.5
CCLN R/L 3225 P12-4CX	ICSN 454	1160	-	-	2415	5004	3.5
CCLN R/L 3225 P12-7CX	ICSN 434	1160	-	-	2415	5004	3.5
CCLN R/L 2525 M16-CX	ICSN 533	1180	-	-	2432	5004	3.5
CCLN R/L 3225 P16-CX	ICSN 533	1180	-	-	2432	5004	3.5

### CNG..

Inserti romboidali negativi 80°.  
Plaquetas rómbicas negativas 80°. **i** D03

Riferimento / Ref.	l	s	d
CNG.. 1204..	12,90	4,76	12,70
CNG.. 1207..	12,90	7,94	12,70
CNG.. 1607..	16,10	7,94	15,88

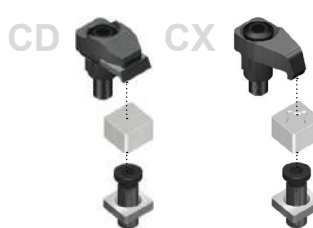
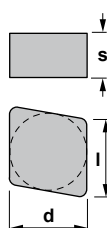

### CNGN



### CNGX





**Caratteristiche:**

Portautensili per operazioni di tornitura e profilatura esterne, montano inserti romboidali negativi bifacciali (angolo 55°).

Per applicazioni generali, sgrossatura, semi-finitura e finitura.

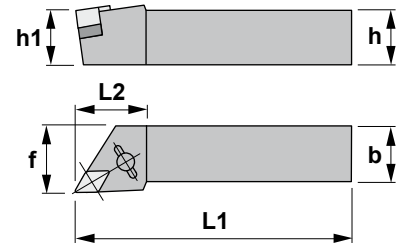

**Características:**

Portaherramientas de torneado exterior y copiado equipado con plaquita rómbica negativa de doble cara (ángulo 55°).

Para aplicaciones generales, desbaste, semiacabados y acabados.

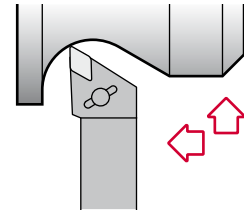

## CDJN 93°

Riferimento Referencia	h=h1	b	L1	L2	f	Dimensioni inserto Medida plaquita	Kg
CDJN R/L 2525 M12-4CD	25	25	150	34	32	DNGN 1204..	0,750
CDJN R/L 2525 M12-7CD	25	25	150	34	32	DNGN 1207..	0,750
CDJN R/L 3225 P12-4CD	32	25	170	34	32	DNGN 1204..	1,050
CDJN R/L 3225 P12-7CD	32	25	170	34	32	DNGN 1207..	1,050
CDJN R/L 2525 M15-CD	25	25	150	38	32	DNGN 1507..	0,750
CDJN R/L 3225 P15-CD	32	25	170	38	32	DNGN 1507..	1,050
CDJN R/L 2525 M12-4CX	25	25	150	34	32	DNGX 1204..	0,750
CDJN R/L 2525 M12-7CX	25	25	150	34	32	DNGX 1207..	0,750
CDJN R/L 3225 P12-4CX	32	25	170	34	32	DNGX 1204..	1,050
CDJN R/L 3225 P12-7CX	32	25	170	34	32	DNGX 1207..	1,050
CDJN R/L 2525 M15-CX	25	25	150	38	32	DNGX 1507..	0,750
CDJN R/L 3225 P15-CX	32	25	170	38	32	DNGX 1507..	1,050

Riferimento Referencia							Nm
CDJN R/L 2525 M12-4CD	IDSN 354	1150	9416	2413	-	5004	3.5
CDJN R/L 2525 M12-7CD	IDSN 334	1150	9416	2413	-	5004	3.5
CDJN R/L 3225 P12-4CD	IDSN 354	1150	9416	2413	-	5004	3.5
CDJN R/L 3225 P12-7CD	IDSN 334	1150	9416	2413	-	5004	3.5
CDJN R/L 2525 M15-CD	IDSN 434	1160	9416	2417	-	5004	3.5
CDJN R/L 3225 P15-CD	IDSN 434	1160	9416	2417	-	5004	3.5
CDJN R/L 2525 M12-4CX	IDSN 354	1150	-	-	2415	5004	3.5
CDJN R/L 2525 M12-7CX	IDSN 334	1150	-	-	2415	5004	3.5
CDJN R/L 3225 P12-4CX	IDSN 354	1150	-	-	2415	5004	3.5
CDJN R/L 3225 P12-7CX	IDSN 334	1150	-	-	2415	5004	3.5
CDJN R/L 2525 M15-CX	IDSN 434	1160	-	-	2432	5004	3.5
CDJN R/L 3225 P15-CX	IDSN 434	1160	-	-	2432	5004	3.5

### DNG..

Inserti romboidali negativi 55°.  
Plaquetas rómbicas negativas 55°. D03-04

Riferimento / Ref.	l	s	d
DNG.. 1204..	12,20	4,76	10,00
DNG.. 1207..	12,20	7,94	10,00
DNG.. 1507..	15,50	7,94	12,70

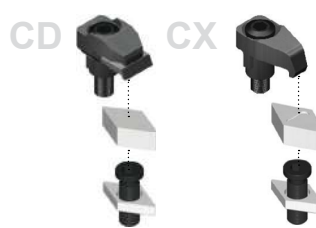
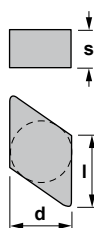

### DNGN



### DNGX





**Caratteristiche:**

Portautensili per molteplici operazioni esterne, montano inserti romboidali negativi bifacciali (angolo 75°).

Per applicazioni generali, sgrossatura, semi-finitura e finitura.

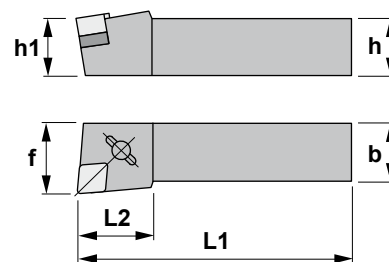

**Características:**

Portaherramientas multifunción equipado con plaquita rómbica negativa de doble cara (ángulo 75°).

Para aplicaciones generales, desbaste, semiacabados y acabados.

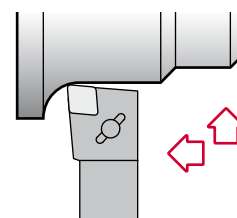

## CELN 97°30'

Riferimento Referencia	h=h1	b	L1	L2	f	Dimensioni inserto Medida plaquita	Kg
CELN R/L 2020 K13-CD	20	20	125	34	25	ENGN 1307..	0,400
CELN R/L 2525 M13-CD	25	25	150	34	32	ENGN 1307..	0,750
CELN R/L 3225 P13-CD	32	25	170	34	32	ENGN 1307..	1,050

Riferimento Referencia						Nm
CELN R/L 2020 K13-CD	IESN 432	1161	9414	2417	5004	3.5
CELN R/L 2525 M13-CD	IESN 432	1160	9414	2417	5004	3.5
CELN R/L 3225 P13-CD	IESN 432	1160	9414	2417	5004	3.5

### ENGN

Inserto romboidale negativo 75°.  
Plaquita rómbica negativa 75° D04

Riferimento / Ref.	l	s	d
ENGN 1307..	13,12	7,94	12,70

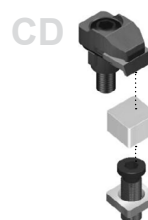
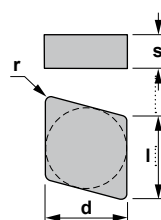

### ENGN



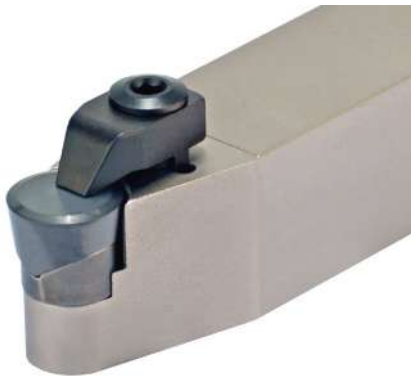

**Caratteristiche:**  
Portautensili per profilatura esterna,  
montano inserti rotondi positivi.  
Per applicazioni generali, sgrossatura,  
semi-finitura e finitura.

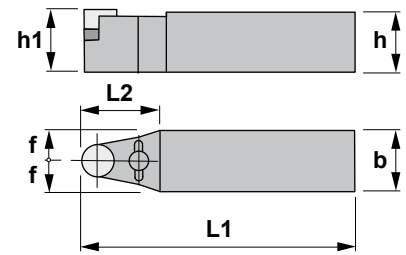

**Características:**  
Portaherramientas de copiado equipado  
con plaquita redonda positiva.  
Para aplicaciones generales, desbaste,  
semiacabados y acabados.

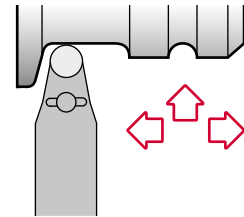

## CRDC

Riferimento Referencia	h=h1	b	L1	L2	f	Dimensioni inserto Medida plaquita	kg
CRDC N 2525 M06	25	25	150	28	12,5	RCGX 0607..	0,750
CRDC N 2525 M09	25	25	150	20	12,5	RCGX 0907..	0,750
CRDC N 3225 P09	32	25	170	20	12,5	RCGX 0907..	0,750
CRDC N 2525 M12	25	25	150	25	12,5	RCGX 1207..	0,750
CRDC N 3225 P12	32	25	170	25	12,5	RCGX 1207..	1,050
CRDC N 2525 M15	25	25	150	30	12,5	RCGX 1507..	0,750
CRDC N 3225 P15	32	25	170	30	12,5	RCGX 1507..	1,050
CRDC N 3225 P19	32	25	170	42	12,5	RCGX 1910..	1,050
CRDC N 3232 P19	32	32	170	42	16,0	RCGX 1910..	1,300
CRDC N 3232 P25	32	32	170	45	16,0	RCGX 2512..	1,300

Riferimento Referencia											Nm
CRDC N 2525 M06	3806	-	-	1392	2120	1335	-	5515	3807	3808	3.0
CRDC N 2525 M09	3849	-	-	1335	2121	1250	-	5520	-	-	4.0
CRDC N 3225 P09	3849	-	-	1335	2121	1250	-	5520	-	-	4.0
CRDC N 2525 M12	3852	-	-	1350	2122	1260	-	5525	-	-	5.0
CRDC N 3225 P12	3852	-	-	1350	2122	1260	-	5525	-	-	5.0
CRDC N 2525 M15	-	3817	-	1230 (2)	2414	-	5004	-	-	-	3.5
CRDC N 3225 P15	-	3817	-	1230 (2)	2414	-	5004	-	-	-	3.5
CRDC N 3225 P19	-	3819	-	1230 (2)	2414	-	5004	-	-	-	3.5
CRDC N 3232 P19	-	3819	9414	1230 (2)	2414	-	5004	-	-	-	3.5
CRDC N 3232 P25	-	3835	9414	1230 (2)	2417	-	5004	-	-	-	3.5

Inserti  
Plaquetas  
RCGX 0606..

Inserti  
Plaquetas  
RCGX 0604..

## RCGX

Inserto rotondo positivo con ángulo de spoglia 7°.  
Plaquita redonda positiva con 7° incidencia. D04

Riferimento / Ref.	a	s	d
RCGX 0607..	120°	7,94	6,35
RCGX 0907..	120°	7,94	9,52
RCGX 1207..	120°	7,94	12,70
RCGX 1507..	120°	7,94	15,87
RCGX 1910..	120°	10,00	19,05
RCGX 1910..	120°	10,00	19,05
RCGX 2512..	140°	12,00	25,40

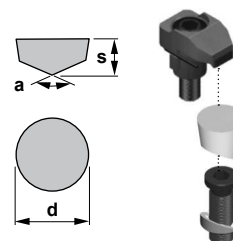

## RCGX





**Caratteristiche:**

Portautensili per molteplici operazioni di profilatura esterna, montano inserti rotondi negativi.

Per applicazioni generali, sgrassatura, semi-finitura e finitura.

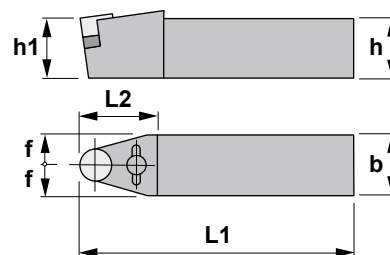

**Características:**

Portaherramientas de copiado equipado con plaquita redonda negativa.

Para aplicaciones generales, desbaste, semiacabados y acabados.

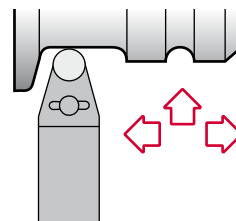

## CRDN

Riferimento Referencia	h=h1	b	L1	L2	f	Dimensioni inserto Medida plaquita	KG
CRDN N 2525 M12-4CD	25	25	150	34	12,5	RNGN 1204..	0,750
CRDN N 2525 M12-7CD	25	25	150	34	12,5	RNGN 1207..	0,750
CRDN N 3225 P12-4CD	32	25	170	34	12,5	RNGN 1204..	1,050
CRDN N 3225 P12-7CD	32	25	170	34	12,5	RNGN 1207..	1,050
CRDN N 2525 M15-7CD	25	25	150	34	12,5	RNGN 1507..	0,750
CRDN N 3225 P15-7CD	32	25	170	42	12,5	RNGN 1507..	1,050
CRDN N 3225 P19-7CD	32	25	170	42	12,5	RNGN 1907..	1,050
CRDN N 3232 P25-7CD	32	32	170	42	16,0	RNGN 2507..	1,300

Riferimento Referencia						Nm
CRDN N 2525 M12-4CD	IRSN 45	1160	2413	9414	5004	3.5
CRDN N 2525 M12-7CD	IRSN 43	1160	2413	9414	5004	3.5
CRDN N 3225 P12-4CD	IRSN 45	1160	2413	9414	5004	3.5
CRDN N 3225 P12-7CD	IRSN 43	1160	2413	9414	5004	3.5
CRDN N 2525 M15-7CD	IRSN 53	1180	2417	9414	5004	3.5
CRDN N 3225 P15-7CD	IRSN 53	1180	2417	9414	5004	3.5
CRDN N 3225 P19-7CD	3919	1182	2417	9414	5004	3.5
CRDN N 3232 P25-7CD	3925	1192	2417	9414	5004	3.5

## RNGN

Inserto rotondo negativo.  
Plaquita redonda negativa. D04

Riferimento / Ref.	s	d
RNGN 1204..	4,76	12,70
RNGN 1207..	7,94	12,70
RNGN 1507..	7,94	15,88
RNGN 1907..	7,94	19,05
RNGN 2507..	7,94	25,40

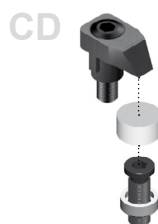
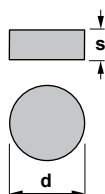

## RNGN





**Caratteristiche:**

Portautensili per molteplici operazioni di profilatura esterna, montano inserti rotondi negativi.

Per applicazioni generali, sgrossatura, semi-finitura e finitura.

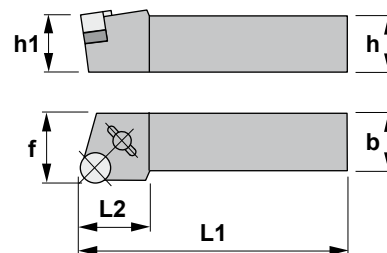

**Características:**

Portaherramientas de copiado equipado con plaquita redonda negativa.

Para aplicaciones generales, desbaste, semiacabados y acabados.

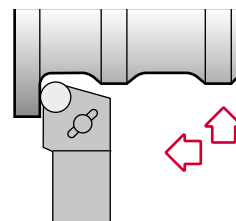

## CRSN

Riferimento Referencia	h=h1	b	L1	L2	f	Dimensioni inserto Medida plaquita	KG
CRSN R/L 2525 M12-4CD	25	25	150	34	32	RNGN 1204..	0,750
CRSN R/L 2525 M12-7CD	25	25	150	34	32	RNGN 1207..	0,750
CRSN R/L 3225 P12-4CD	32	25	170	34	32	RNGN 1204..	1,050
CRSN R/L 3225 P12-7CD	32	25	170	34	32	RNGN 1207..	1,050

Riferimento Referencia						Nm
CRSN R/L 2525 M12-4CD	IRSN 45	1160	2413	9414	5004	3.5
CRSN R/L 2525 M12-7CD	IRSN 43	1160	2413	9414	5004	3.5
CRSN R/L 3225 P12-4CD	IRSN 45	1160	2413	9414	5004	3.5
CRSN R/L 3225 P12-7CD	IRSN 43	1160	2413	9414	5004	3.5

### RNGN

Inserto rotondo negativo.  
Plaquita redonda negativa. D04

Riferimento / Ref.	s	d
RNGN 1204..	4,76	12,70
RNGN 1207..	7,94	12,70

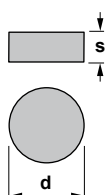

### RNGN





**Caratteristiche:**

Portautensili per applicazioni di tornitura esterne e spallamento, montano inserti quadrati negativi.

Per applicazioni generali, sgrossatura, semi-finitura e finitura.

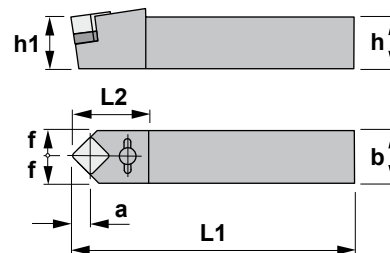

**Características:**

Portaherramientas de torneado exterior y achaflanado equipado con plaquita cuadrada negativa.

Para aplicaciones generales, desbaste, semiacabados y acabados.

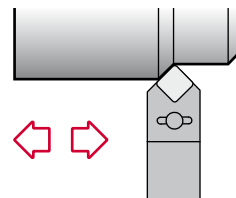

## CSDN 45°

Riferimento Referencia	h=h1	b	L1	L2	f	a	Dimensioni inserto Medida plaquita	
CSDN N 2525 M12-4CD	25	25	150	42	12,5	8,32	SNGN 1204..	0,750
CSDN N 2525 M12-7CD	25	25	150	42	12,5	8,32	SNGN 1207..	0,750
CSDN N 3225 P12-4CD	32	25	170	42	12,5	8,32	SNGN 1204..	1,050
CSDN N 3225 P12-7CD	32	25	170	42	12,5	10,23	SNGN 1207..	1,050
CSDN N 2525 M15-CD	25	25	150	42	12,5	8,32	SNGN 1507..	0,750
CSDN N 3225 P15-CD	32	25	170	42	12,5	10,23	SNGN 1507..	1,050
CSDN N 2525 M12-4CX	25	25	150	42	12,5	8,32	SNGX 1204..	0,750
CSDN N 2525 M12-7CX	25	25	150	42	12,5	8,32	SNGX 1207..	0,750
CSDN N 3225 P12-4CX	32	25	170	42	12,5	8,32	SNGX 1204..	1,050
CSDN N 3225 P12-7CX	32	25	170	42	12,5	8,32	SNGX 1207..	1,050
CSDN N 2525 M15-CX	25	25	150	42	12,5	10,23	SNGX 1507..	0,750
CSDN N 3225 P15-CX	32	25	170	42	12,5	10,23	SNGX 1507..	1,050

Riferimento Referencia						Nm	
CSDN N 2525 M12-4CD	ISSN 454	1160	9414	2417	-	5004	3.5
CSDN N 2525 M12-7CD	ISSN 434	1160	9414	2417	-	5004	3.5
CSDN N 3225 P12-4CD	ISSN 454	1160	9414	2417	-	5004	3.5
CSDN N 3225 P12-7CD	ISSN 434	1160	9414	2417	-	5004	3.5
CSDN N 2525 M15-CD	ISSN 534	1180	9414	2417	-	5004	3.5
CSDN N 3225 P15-CD	ISSN 534	1180	9414	2417	-	5004	3.5
CSDN N 2525 M12-4CX	ISSN 454	1160	-	-	2415	5004	3.5
CSDN N 2525 M12-7CX	ISSN 434	1160	-	-	2415	5004	3.5
CSDN N 3225 P12-4CX	ISSN 454	1160	-	-	2415	5004	3.5
CSDN N 3225 P12-7CX	ISSN 434	1160	-	-	2415	5004	3.5
CSDN N 2525 M15-CX	ISSN 534	1180	-	-	2415	5004	3.5
CSDN N 3225 P15-CX	ISSN 534	1180	-	-	2415	5004	3.5

### SNG..

Inserti quadrati negativi.  
Plaquetas cuadradas negativas. D05-06

Riferimento / Ref.	l	s	d
SNG.. 1204..	12,70	4,76	12,70
SNG.. 1207..	12,70	7,94	12,70
SNG.. 1507..	15,87	7,94	15,87

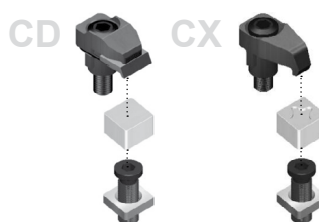
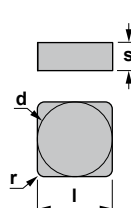

### SNGN



### SNGX





**Caratteristiche:**

Portautensili per applicazioni esterne di sfacciatura, montano inserti quadrati negativi con spigoli di taglio resistenti. Per applicazioni generali, sgrossatura, semi-finitura e finitura.

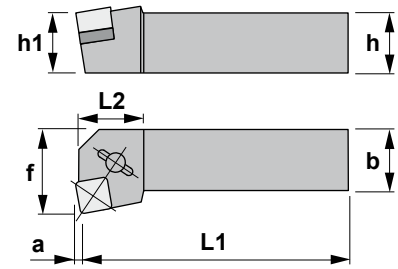

**Características:**

Portaherramientas para aplicaciones de refrentado equipado con plaquita cuadrada negativa. Para aplicaciones generales, desbaste, semiacabados y acabados.

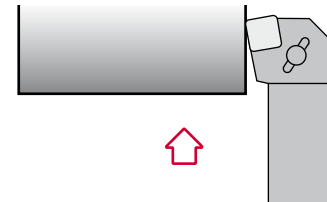

## CSKN 75°

Riferimento Referencia	h=h1	b	L1	L2	f	a	Dimensioni inserto Medida plaquita	KG
CSKN R/L 2525 M12-4CD	25	25	150	34	32	3,06	SNGN 1204..	0,750
CSKN R/L 2525 M12-7CD	25	25	150	34	32	3,06	SNGN 1207..	0,750
CSKN R/L 3225 P12-4CD	32	25	170	34	32	3,06	SNGN 1204..	1,050
CSKN R/L 3225 P12-7CD	32	25	170	34	32	3,06	SNGN 1207..	1,050
CSKN R/L 2525 M15-CD	25	25	150	34	32	3,77	SNGN 1507..	0,750
CSKN R/L 3225 P15-CD	32	25	170	34	32	3,77	SNGN 1507..	1,050
CSKN R/L 2525 M12-4CX	25	25	150	34	32	3,06	SNGX 1204..	0,750
CSKN R/L 2525 M12-7CX	25	25	150	34	32	3,06	SNGX 1207..	0,750
CSKN R/L 3225 P12-4CX	32	25	170	34	32	3,06	SNGX 1207..	1,050
CSKN R/L 3225 P12-7CX	32	25	170	34	32	3,06	SNGX 1207..	1,050
CSKN R/L 2525 M15-CX	25	25	150	34	32	3,77	SNGX 1507..	0,750
CSKN R/L 3225 P15-CX	32	25	170	34	32	3,77	SNGX 1507..	1,050
CSKN R/L 4040 P15-CX	40	40	170	34	50	3,77	SNGX 1507..	1,300

Riferimento Referencia						Nm	
CSKN R/L 2525 M12-4CD	ISSN 454	1160	9414	2417	-	5004	3.5
CSKN R/L 2525 M12-7CD	ISSN 434	1160	9414	2417	-	5004	3.5
CSKN R/L 3225 P12-4CD	ISSN 454	1160	9414	2417	-	5004	3.5
CSKN R/L 3225 P12-7CD	ISSN 434	1160	9414	2417	-	5004	3.5
CSKN R/L 2525 M15-CD	ISSN 534	1180	9414	2417	-	5004	3.5
CSKN R/L 3225 P15-CD	ISSN 534	1180	9414	2417	-	5004	3.5
CSKN R/L 2525 M12-4CX	ISSN 454	1160	-	-	2415	5004	3.5
CSKN R/L 2525 M12-7CX	ISSN 434	1160	-	-	2415	5004	3.5
CSKN R/L 3225 P12-4CX	ISSN 454	1160	-	-	2415	5004	3.5
CSKN R/L 3225 P12-7CX	ISSN 434	1160	-	-	2415	5004	3.5
CSKN R/L 2525 M15-CX	ISSN 534	1180	-	-	2415	5004	3.5
CSKN R/L 3225 P15-CX	ISSN 534	1180	-	-	2415	5004	3.5
CSKN R/L 4040 P15-CX	ISSN 534	1180	-	-	2415	5004	3.5

### SNG..

Inserti quadrati negativi.  
Plaquetas cuadradas negativas. D05-06

Riferimento / Ref.	l	s	d
SNG.. 1204..	12,70	4,76	12,70
SNG.. 1207..	12,70	7,94	12,70
SNG.. 1507..	15,87	7,94	15,87

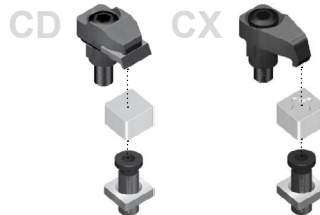
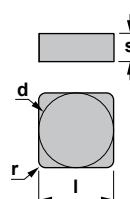

### SNGN



### SNGX





**Caratteristiche:**

Portautensili per applicazioni di tornitura esterna, montano inserti quadrati negativi. Per applicazioni generali, sgrossatura, semi-finitura e finitura.

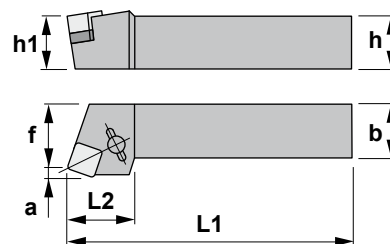

**Características:**

Portaherramientas para aplicaciones de torneado exterior equipado con plaquita cuadrada negativa.

Para aplicaciones generales, desbaste, semiacabados y acabados.

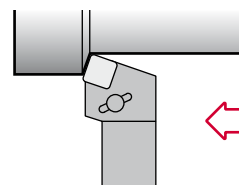

## CSRN 75°

Riferimento Referencia	h=h1	b	L1	L2	f	a	Dimensioni inserto Medida plaquita	Kg
CSRN R/L 2525 M12-4CD	25	25	150	34	27	3,06	SNGN 1204..	0,750
CSRN R/L 2525 M12-7CD	25	25	150	34	27	3,06	SNGN 1207..	0,750
CSRN R/L 3225 P12-4CD	32	25	170	34	27	3,06	SNGN 1204..	1,050
CSRN R/L 3225 P12-7CD	32	25	170	34	27	3,06	SNGN 1207..	1,050
CSRN R/L 2525 M15-CD	25	25	150	34	27	3,77	SNGN 1507..	0,750
CSRN R/L 3225 P15-CD	32	25	170	38	27	3,77	SNGN 1507..	1,050
CSRN R/L 3232 P19-CD	32	32	170	42	35	4,50	SNGN 1907..	1,150
CSRN R/L 4040 P19-CD	40	40	170	42	43	4,50	SNGN 1907..	1,300
CSRN R/L 2525 M12-4CX	25	25	150	34	27	3,06	SNGX 1204..	0,750
CSRN R/L 2525 M12-7CX	25	25	150	34	27	3,06	SNGX 1207..	0,750
CSRN R/L 3225 P12-4CX	32	25	170	34	27	3,06	SNGX 1204..	1,050
CSRN R/L 3225 P12-7CX	32	25	170	34	27	3,06	SNGX 1207..	1,050
CSRN R/L 2525 M15-CX	25	25	150	34	27	3,77	SNGX 1507..	0,750
CSRN R/L 3225 P15-CX	32	25	170	38	27	3,77	SNGX 1507..	1,050

Riferimento Referencia								Nm
CSRN R/L 2525 M12-4CD	ISSN 454	1160	9414	2417	-	5004	3.5	
CSRN R/L 2525 M12-7CD	ISSN 434	1160	9414	2417	-	5004	3.5	
CSRN R/L 3225 P12-4CD	ISSN 454	1160	9414	2417	-	5004	3.5	
CSRN R/L 3225 P12-7CD	ISSN 434	1160	9414	2417	-	5004	3.5	
CSRN R/L 2525 M15-CD	ISSN 534	1180	9414	2417	-	5004	3.5	
CSRN R/L 3225 P15-CD	ISSN 534	1180	9414	2417	-	5004	3.5	
CSRN R/L 3232 P19-CD	3519	1182	9414	2417	-	5004	3.5	
CSRN R/L 4040 P19-CD	3519	1182	9414	2417	-	5004	3.5	
CSRN R/L 2525 M12-4CX	ISSN 454	1160	-	-	2415	5004	3.5	
CSRN R/L 2525 M12-7CX	ISSN 434	1160	-	-	2415	5004	3.5	
CSRN R/L 3225 P12-4CX	ISSN 454	1160	-	-	2415	5004	3.5	
CSRN R/L 3225 P12-7CX	ISSN 434	1160	-	-	2415	5004	3.5	
CSRN R/L 2525 M15-CX	ISSN 534	1180	-	-	2415	5004	3.5	
CSRN R/L 3225 P15-CX	ISSN 534	1180	-	-	2415	5004	3.5	

### SNG..

Inserti quadrati negativi.  
Plaquetas cuadradas negativas. D05-06

Riferimento / Ref.	l	s	d
SNG.. 1204..	12,70	4,76	12,70
SNG.. 1207..	12,70	7,94	12,70
SNG.. 1507..	15,87	7,94	15,87

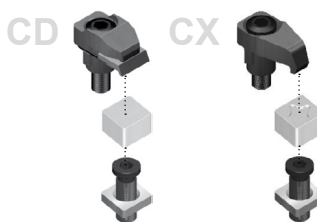
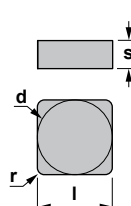

### SNGN



### SNGX





**Caratteristiche:**

Portautensili per applicazioni di tornitura esterne e spallamento, montano inserti quadrati negativi.

Per applicazioni generali, sgrossatura, semi-finitura e finitura.

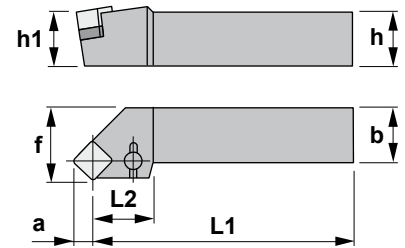

**Características:**

Portaherramientas para aplicaciones de torneado exterior y achaflanado equipado con plaquita cuadrada negativa.

Para aplicaciones generales, desbaste, semiacabados y acabados.

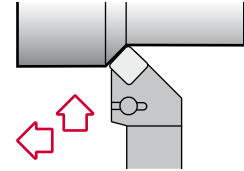

## CSSN 45°

Riferimento Referencia	h=h1	b	L1	L2	f	a	Dimensioni inserto Medida plaquita	/kg
CSSN R/L 2525 M12-4CD	25	25	150	35	32	8,32	SNGN 1204..	0,750
CSSN R/L 2525 M12-7CD	25	25	150	35	32	8,32	SNGN 1207..	0,750
CSSN R/L 3225 P12-4CD	32	25	170	35	32	8,32	SNGN 1204..	1,050
CSSN R/L 3225 P12-7CD	32	25	170	35	32	8,32	SNGN 1207..	1,050
CSSN R/L 2525 M15-CD	25	25	150	37	32	10,23	SNGN 1507..	0,750
CSSN R/L 3225 P15-CD	32	25	170	37	32	10,23	SNGN 1507..	1,050
CSSN R/L 3232 P19-CD	32	32	170	37	40	12,50	SNGN 1907..	1,150
CSSN R/L 4040 P19-CD	40	40	170	37	50	12,50	SNGN 1907..	1,300
CSSN R/L 2525 M12-4CX	25	25	150	35	32	8,32	SNGX 1204..	0,750
CSSN R/L 2525 M12-7CX	25	25	150	35	32	8,32	SNGX 1207..	0,750
CSSN R/L 3225 P12-4CX	32	25	170	35	32	8,32	SNGX 1204..	1,050
CSSN R/L 3225 P12-7CX	32	25	170	35	32	8,32	SNGX 1207..	1,050
CSSN R/L 2525 M15-CX	25	25	150	37	32	10,23	SNGX 1507..	0,750
CSSN R/L 3225 P15-CX	32	25	170	37	32	10,23	SNGX 1507..	1,050

Riferimento Referencia							Nm
CSSN R/L 2525 M12-4CD	ISSN 454	1160	9414	2417	-	5004	3.5
CSSN R/L 2525 M12-7CD	ISSN 434	1160	9414	2417	-	5004	3.5
CSSN R/L 3225 P12-4CD	ISSN 454	1160	9414	2417	-	5004	3.5
CSSN R/L 3225 P12-7CD	ISSN 434	1160	9414	2417	-	5004	3.5
CSSN R/L 2525 M15-CD	ISSN 534	1180	9414	2417	-	5004	3.5
CSSN R/L 3225 P15-CD	ISSN 534	1180	9414	2417	-	5004	3.5
CSSN R/L 3232 P19-CD	3519	1182	9414	2417	-	5004	3.5
CSSN R/L 4040 P19-CD	3519	1182	9414	2417	-	5004	3.5
CSSN R/L 2525 M12-4CX	ISSN 454	1160	-	-	2415	5004	3.5
CSSN R/L 2525 M12-7CX	ISSN 434	1160	-	-	2415	5004	3.5
CSSN R/L 3225 P12-4CX	ISSN 454	1160	-	-	2415	5004	3.5
CSSN R/L 3225 P12-7CX	ISSN 434	1160	-	-	2415	5004	3.5
CSSN R/L 2525 M15-CX	ISSN 534	1180	-	-	2415	5004	3.5
CSSN R/L 3225 P15-CX	ISSN 534	1180	-	-	2415	5004	3.5

### SNG..

Inserti quadrati negativi.  
Plaquetas cuadradas negativas. D05-06

Riferimento / Ref.	l	s	d
SNG.. 1204..	12,70	4,76	12,70
SNG.. 1207..	12,70	7,94	12,70
SNG.. 1507..	15,87	7,94	15,87

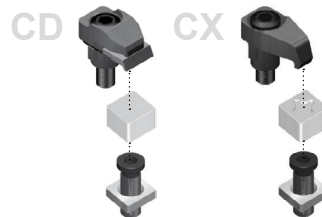
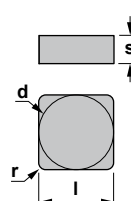

### SNGN



### SNGX





**Caratteristiche:**

Portautensili per applicazioni di tornitura esterna, montano inserti quadrati negativi. Per applicazioni generali, sgrossatura, semi-finitura e finitura.

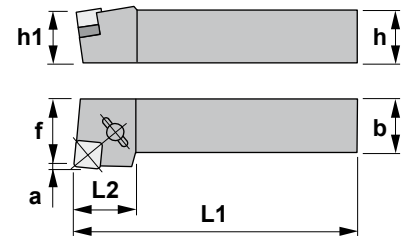

**Características:**

Portaherramientas para aplicaciones de torneado exterior equipado con plaquita cuadrada negativa.

Para aplicaciones generales, desbaste, semiacabados y acabados.

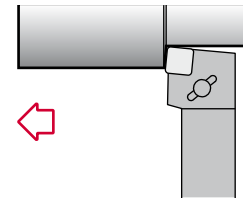

## CSXN 85°

Riferimento Referencia	h=h1	b	L1	L2	f	a	Dimensioni inserto Medida plaquita	KG
CSXN R/L 2525 M12-4CD	25	25	150	30	32	1,03	SNGN 1204..	0,750
CSXN R/L 2525 M12-7CD	25	25	150	30	32	1,03	SNGN 1207..	0,750
CSXN R/L 3225 P12-4CD	32	25	170	30	32	1,03	SNGN 1204..	1,050
CSXN R/L 3225 P12-7CD	32	25	170	30	32	1,03	SNGN 1207..	1,050
CSXN R/L 2525 M15-CD	25	25	150	33	32	1,38	SNGN 1507..	0,750
CSXN R/L 3225 P15-CD	32	25	170	33	32	1,38	SNGN 1507..	1,050
CSXN R/L 2525 M12-4CX	25	25	150	30	32	1,03	SNGX 1204..	0,750
CSXN R/L 2525 M12-7CX	25	25	150	30	32	1,03	SNGX 1207..	0,750
CSXN R/L 3225 P12-4CX	32	25	170	30	32	1,03	SNGX 1204..	1,050
CSXN R/L 3225 P12-7CX	32	25	170	30	32	1,03	SNGX 1207..	1,050
CSXN R/L 2525 M15-CX	25	25	150	33	32	1,38	SNGX 1507..	0,750
CSXN R/L 3225 P15-CX	32	25	170	33	32	1,38	SNGX 1507..	1,050

Riferimento Referencia							Nm
CSXN R/L 2525 M12-4CD	ISSN 454	1160	9414	2417	-	5004	3.5
CSXN R/L 2525 M12-7CD	ISSN 434	1160	9414	2417	-	5004	3.5
CSXN R/L 3225 P12-4CD	ISSN 454	1160	9414	2417	-	5004	3.5
CSXN R/L 3225 P12-7CD	ISSN 434	1160	9414	2417	-	5004	3.5
CSXN R/L 2525 M15-CD	ISSN 534	1180	9414	2417	-	5004	3.5
CSXN R/L 3225 P15-CD	ISSN 534	1180	9414	2417	-	5004	3.5
CSXN R/L 2525 M12-4CX	ISSN 454	1160	-	-	2415	5004	3.5
CSXN R/L 2525 M12-7CX	ISSN 434	1160	-	-	2415	5004	3.5
CSXN R/L 3225 P12-4CX	ISSN 454	1160	-	-	2415	5004	3.5
CSXN R/L 3225 P12-7CX	ISSN 434	1160	-	-	2415	5004	3.5
CSXN R/L 2525 M15-CX	ISSN 534	1180	-	-	2415	5004	3.5
CSXN R/L 3225 P15-CX	ISSN 534	1180	-	-	2415	5004	3.5

### SNG..

Inserti quadrati negativi.  
Plaquetas cuadradas negativas. D05-06

Riferimento / Ref.	l	s	d
SNG.. 1204..	12,70	4,76	12,70
SNG.. 1207..	12,70	7,94	12,70
SNG.. 1507..	15,87	7,94	15,87

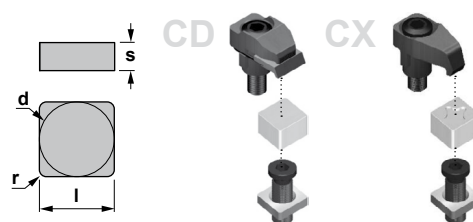

### SNGN



### SNGX





**Caratteristiche:**

Portautensili per applicazioni di tornitura esterna frontale, montano inserti quadrati negativi.

Per applicazioni generali, sgrossatura, semi-finitura e finitura.

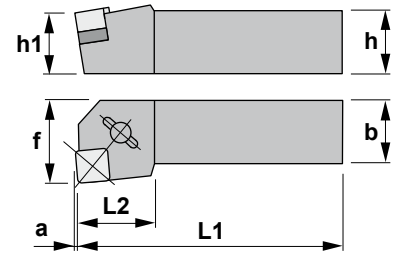

**Características:**

Portaherramientas para refrentar equipado con plaquita cuadrada negativa.

Para aplicaciones generales, desbaste, semiacabados y acabados.

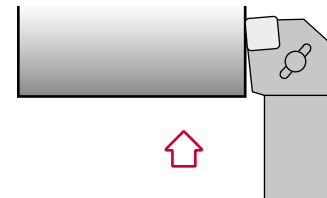

## CSYN 85°

Riferimento Referencia	h=h1	b	L1	L2	f	a	Dimensioni inserto Medida plaquita	KG
CSYN R/L 2525 M12-4CD	25	25	150	27	32	1,03	SNGN 1204..	0,750
CSYN R/L 2525 M12-7CD	25	25	150	27	32	1,03	SNGN 1207..	0,750
CSYN R/L 3225 P12-4CD	32	25	170	27	32	1,03	SNGN 1204..	1,050
CSYN R/L 3225 P12-7CD	32	25	170	27	32	1,03	SNGN 1207..	1,050
CSYN R/L 2525 M15-CD	25	25	150	27	32	1,38	SNGN 1507..	0,750
CSYN R/L 3225 P15-CD	32	25	170	27	32	1,38	SNGN 1507..	1,050
CSYN R/L 2525 M12-4CX	25	25	150	27	32	1,03	SNGX 1204..	0,750
CSYN R/L 2525 M12-7CX	25	25	150	27	32	1,03	SNGX 1207..	0,750
CSYN R/L 3225 P12-4CX	32	25	170	27	32	1,03	SNGX 1204..	1,050
CSYN R/L 3225 P12-7CX	32	25	170	27	32	1,03	SNGX 1207..	1,050
CSYN R/L 2525 M15-CX	25	25	150	27	32	1,38	SNGX 1507..	0,750
CSYN R/L 3225 P15-CX	32	25	170	27	32	1,38	SNGX 1507..	1,050

Riferimento Referencia							Nm
CSYN R/L 2525 M12-4CD	ISSN 454	1160	9414	2417	-	5004	3.5
CSYN R/L 2525 M12-7CD	ISSN 434	1160	9414	2417	-	5004	3.5
CSYN R/L 3225 P12-4CD	ISSN 454	1160	9414	2417	-	5004	3.5
CSYN R/L 3225 P12-7CD	ISSN 434	1160	9414	2417	-	5004	3.5
CSYN R/L 2525 M15-CD	ISSN 534	1180	9414	2417	-	5004	3.5
CSYN R/L 3225 P15-CD	ISSN 534	1180	9414	2417	-	5004	3.5
CSYN R/L 2525 M12-4CX	ISSN 454	1160	-	-	2415	5004	3.5
CSYN R/L 2525 M12-7CX	ISSN 434	1160	-	-	2415	5004	3.5
CSYN R/L 3225 P12-4CX	ISSN 454	1160	-	-	2415	5004	3.5
CSYN R/L 3225 P12-7CX	ISSN 434	1160	-	-	2415	5004	3.5
CSYN R/L 2525 M15-CX	ISSN 534	1180	-	-	2415	5004	3.5
CSYN R/L 3225 P15-CX	ISSN 534	1180	-	-	2415	5004	3.5

### SNG..

Inserti quadrati negativi.  
Plaquetas cuadradas negativas. D05-06

Riferimento / Ref.	l	s	d
SNG.. 1204..	12,70	4,76	12,70
SNG.. 1207..	12,70	7,94	12,70
SNG.. 1507..	15,87	7,94	15,87

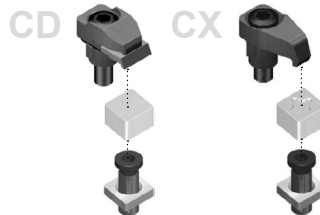
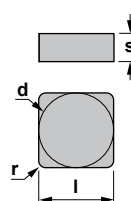

### SNGN



### SNGX





**Caratteristiche:**

Portautensili per applicazioni esterne di sfacciatura, montano inserti triangolari negativi.

Per applicazioni generali, sgrossatura, semi-finitura e finitura.

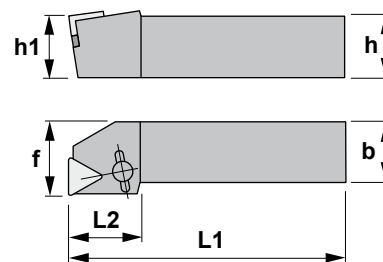

**Características:**

Portaherramientas para refrentar equipado con plaquita triangular negativa.

Para aplicaciones generales, desbaste, semiacabados y acabados.

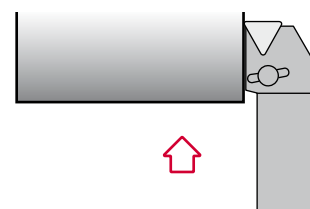

## CTFN 90°

Riferimento Referencia	h=h1	b	L1	L2	f	Dimensioni inserto Medida plaquita	Kg
CTFN R/L 2525 M16-4CD	25	25	150	29	32	TNGN 1604..	0,750
CTFN R/L 2525 M16-7CD	25	25	150	29	32	TNGN 1607..	0,750
CTFN R/L 3225 P16-4CD	32	25	170	29	32	TNGN 1604..	1,050
CTFN R/L 3225 P16-7CD	32	25	170	29	32	TNGN 1607..	1,050

Riferimento Referencia						Nm
CTFN R/L 2525 M16-4CD	ITSN 342	1150	9416	2413	5004	3.5
CTFN R/L 2525 M16-7CD	ITSN 324	1150	9416	2413	5004	3.5
CTFN R/L 3225 P16-4CD	ITSN 342	1150	9416	2417	5004	3.5
CTFN R/L 3225 P16-7CD	ITSN 324	1150	9416	2417	5004	3.5

### TNGN

Inserto triangolare negativo. D06  
Plaquita triangular negativa.

Riferimento / Ref.	l	s	d
TNGN 1604..	16,50	4,76	9,52
TNGN 1607..	16,50	7,94	9,52

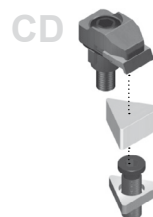
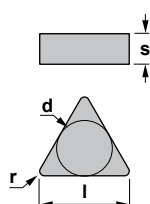

### TNGN



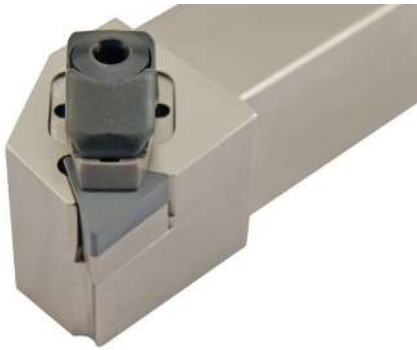

**Caratteristiche:**

Portautensili per applicazioni di tornitura esterna, montano inserti triangolari negativi. Per applicazioni generali, sgrossatura, semi-finitura e finitura.

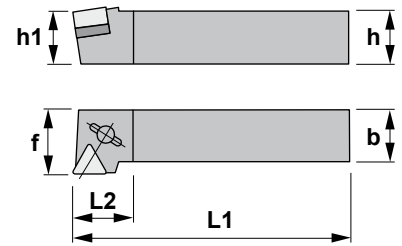

**Características:**

Portaherramientas para aplicaciones de torneado exterior equipado con plaquita triangular negativa. Para aplicaciones generales, desbaste, semiacabados y acabados.

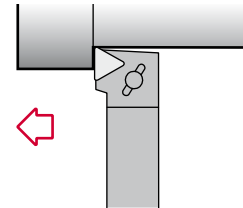

## CTGN 90°

Riferimento Referencia	h=h1	b	L1	L2	f	Dimensioni inserto Medida plaquita	Kg
CTGN R/L 2525 M16-4CD	25	25	150	20	32	TNGN 1604..	0,750
CTGN R/L 2525 M16-7CD	25	25	150	20	32	TNGN 1607..	0,750
CTGN R/L 3225 P16-4CD	32	25	170	20	32	TNGN 1604..	1,050
CTGN R/L 3225 P16-7CD	32	25	170	20	32	TNGN 1607..	1,050

Riferimento Referencia						Nm
CTGN R/L 2525 M16-4CD	ITSN 342	1150	9416	2413	5004	3.5
CTGN R/L 2525 M16-7CD	ITSN 324	1150	9416	2413	5004	3.5
CTGN R/L 3225 P16-4CD	ITSN 342	1150	9416	2413	5004	3.5
CTGN R/L 3225 P16-7CD	ITSN 324	1150	9416	2413	5004	3.5

<b>TNGN</b>				Inserto triangolare negativo. Plaquita triangular negativa.  D06		<b>TNGN</b>	
Riferimento / Ref.	l	s	d				
TNGN 1604..	16,50	4,76	9,52				
TNGN 1607..	16,50	7,94	9,52				





**Caratteristiche:**

Portautensili per applicazioni di tornitura e profilatura esterne, montano inserti romboidali negativi bifacciali (angolo 35°). Per applicazioni generali, sgrossatura, semi-finitura e finitura.

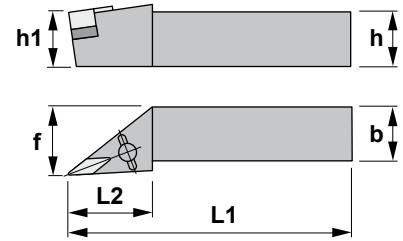

**Características:**

Portaherramientas para aplicaciones de torneado exterior y copiado equipado con plaqueta rómbica negativa de doble cara (ángulo 35°).

Para aplicaciones generales, desbaste, semiacabados y acabados.

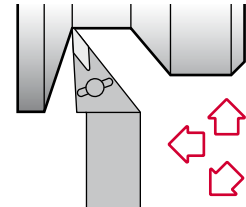

## CVJN 93°

Riferimento Referencia	h=h1	b	L1	L2	f	Dimensioni inserto Medida plaquita	
CVJN R/L 2525 M16-4CD	25	25	150	41	32	VNGN 1604..	0,750
CVJN R/L 2525 M16-7CD	25	25	150	41	32	VNGN 1607..	0,750
CVJN R/L 3225 P16-4CD	32	25	170	41	32	VNGN 1604..	1,050
CVJN R/L 3225 P16-7CD	32	25	170	41	32	VNGN 1607..	1,050
CVJN R/L 2525 M16-4CX	25	25	150	41	32	VNGX 1604..	0,750
CVJN R/L 2525 M16-7CX	25	25	150	41	32	VNGX 1607..	0,750
CVJN R/L 3225 P16-4CX	32	25	170	41	32	VNGX 1604..	1,050
CVJN R/L 3225 P16-7CX	32	25	170	41	32	VNGX 1607..	1,050

Riferimento Referencia								Nm
CVJN R/L 2525 M16-4CD	IVSN 342	1150	9416	2417	-	5004	3.5	
CVJN R/L 2525 M16-7CD	IVSN 322	1150	9416	2417	-	5004	3.5	
CVJN R/L 3225 P16-4CD	IVSN 342	1150	9416	2417	-	5004	3.5	
CVJN R/L 3225 P16-7CD	IVSN 322	1150	9416	2417	-	5004	3.5	
CVJN R/L 2525 M16-4CX	IVSN 342	1150	-	-	2428	5004	3.5	
CVJN R/L 2525 M16-7CX	IVSN 322	1150	-	-	2428	5004	3.5	
CVJN R/L 3225 P16-4CX	IVSN 342	1150	-	-	2428	5004	3.5	
CVJN R/L 3225 P16-7CX	IVSN 322	1150	-	-	2428	5004	3.5	

### VNG..

Inserti romboidali negativi 35°.  
Plaquetas rómbicas negativas 35°.

Riferimento / Ref.	l	s	d
VNG.. 1604..	16,50	4,76	9,52
VNG.. 1607..	16,50	7,94	9,52

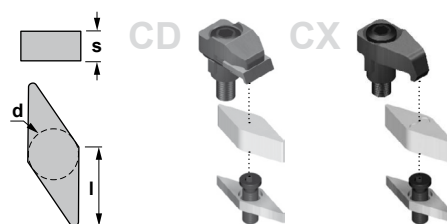

#### VNGN



#### VNGX





**Caratteristiche:**

Portautensili per applicazioni di tornitura e profilatura esterne, montano inserti romboidali negativi bifacciali (angolo 35°).

Per applicazioni generali, sgrossatura, semi-finitura e finitura.

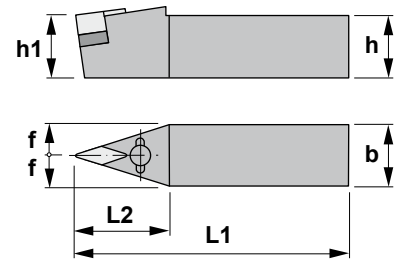

**Características:**

Portaherramientas para aplicaciones de torneado exterior y copiado equipado con plaquita rómbica negativa de doble cara (ángulo 35°).

Para aplicaciones generales, desbaste, semiacabados y acabados.

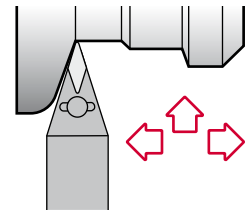

## CVVN 62°30'

Riferimento Referencia	h=h1	b	L1	L2	f	Dimensioni inserto Medida plaquita	⚖️ Kg
CVVN N 2525 M16-4CD	25	25	150	45	12,5	VNGN 1604..	0,750
CVVN N 2525 M16-7CD	25	25	150	45	12,5	VNGN 1607..	0,750
CVVN N 3225 P16-4CD	32	25	170	45	12,5	VNGN 1604..	1,050
CVVN N 3225 P16-7CD	32	25	170	45	12,5	VNGN 1607..	1,050
CVVN N 2525 M16-4CX	25	25	150	45	12,5	VNGX 1604..	0,750
CVVN N 2525 M16-7CX	25	25	150	45	12,5	VNGX 1607..	0,750
CVVN N 3225 P16-4CX	32	25	170	45	12,5	VNGX 1604..	1,050
CVVN N 3225 P16-7CX	32	25	170	45	12,5	VNGX 1607..	1,050

Riferimento Referencia							Nm
CVVN N 2525 M16-4CD	IVSN 342	1150	9416	2417	-	5004	3.5
CVVN N 2525 M16-7CD	IVSN 322	1150	9416	2417	-	5004	3.5
CVVN N 3225 P16-4CD	IVSN 342	1150	9416	2417	-	5004	3.5
CVVN N 3225 P16-7CD	IVSN 322	1150	9416	2417	-	5004	3.5
CVVN N 2525 M16-4CX	IVSN 342	1150	-	-	2428	5004	3.5
CVVN N 2525 M16-7CX	IVSN 322	1150	-	-	2428	5004	3.5
CVVN N 3225 P16-4CX	IVSN 342	1150	-	-	2428	5004	3.5
CVVN N 3225 P16-7CX	IVSN 322	1150	-	-	2428	5004	3.5

VNG..				Inserti romboidali negativi 35°. Plaquetas rómbicas negativas 35°.			
Riferimento / Ref.	l	s	d			VNGN	VNGX
VNG.. 1604..	16,50	4,76	9,52				
VNG.. 1607..	16,50	7,94	9,52				





**Caratteristiche:**

Portautensili per molteplici operazioni di tornitura interna, montano inserti romboidali negativi bifacciali (angolo 80°).  
Per applicazioni generali, sgrossatura, semi-finitura e finitura.

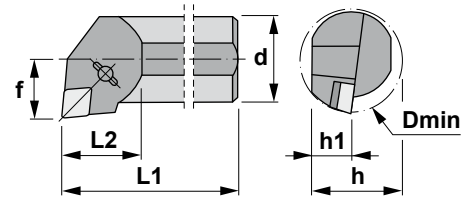

**Características:**

Barra de mandrinar multifunción equipada con plaquita rómbica negativa de doble cara (ángulo 80°).  
Para aplicaciones generales, desbaste, semiacabados y acabados.

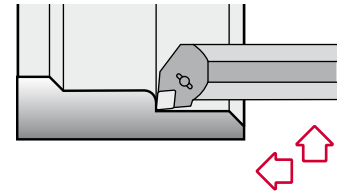

## CCLN 95°

Riferimento Referencia	d	h1	L1	L2	f	h	Dmin	Dimensioni inserto Medida plaquita	KG
S32S CCLN R/L 12-7CD	32	15,0	250	40	22	30	40	CNGN 1207..	1,450
S40T CCLN R/L 12-4CD	40	18,5	300	35	27	37	70	CNGN 1204..	2,700
S40T CCLN R/L 12-7CD	40	18,5	300	35	27	37	70	CNGN 1207..	2,700
S50U CCLN R/L 12-4CD	50	23,5	350	38	32	47	70	CNGN 1204..	4,950
S50U CCLN R/L 12-7CD	50	23,5	350	38	32	47	70	CNGN 1207..	4,950
S32S CCLN R/L 12-7CX	32	15,0	250	40	22	30	40	CNGX 1207..	1,450
S40T CCLN R/L 12-4CX	40	18,5	300	35	27	37	70	CNGX 1204..	2,700
S40T CCLN R/L 12-7CX	40	18,5	300	35	27	37	70	CNGX 1207..	2,700
S50U CCLN R/L 12-4CX	50	23,5	350	38	32	47	70	CNGX 1204..	4,950
S50U CCLN R/L 12-7CX	50	23,5	350	38	32	47	70	CNGX 1207..	4,950

Riferimento Referencia							Nm
S32S CCLN R/L 12-7CD	-	-	9414	2417	-	5004	3.5
S40T CCLN R/L 12-4CD	ICSN 454	1161	9414	2417	-	5004	3.5
S40T CCLN R/L 12-7CD	ICSN 434	1161	9414	2417	-	5004	3.5
S50U CCLN R/L 12-4CD	ICSN 454	1160	9414	2417	-	5004	3.5
S50U CCLN R/L 12-7CD	ICSN 434	1160	9414	2417	-	5004	3.5
S32S CCLN R/L 12-7CX	-	-	-	-	2415	5004	3.5
S40T CCLN R/L 12-4CX	ICSN 454	1161	-	-	2415	5004	3.5
S40T CCLN R/L 12-7CX	ICSN 434	1161	-	-	2415	5004	3.5
S50U CCLN R/L 12-4CX	ICSN 454	1160	-	-	2415	5004	3.5
S50U CCLN R/L 12-7CX	ICSN 434	1160	-	-	2415	5004	3.5

### CNG..

Inserti romboidali negativi 80°.  
Plaquetas rómbicas negativas 80°. D03

Riferimento / Ref.	l	s	d
CNG.. 1204..	12,90	4,76	12,70
CNG.. 1207..	12,90	7,94	12,70

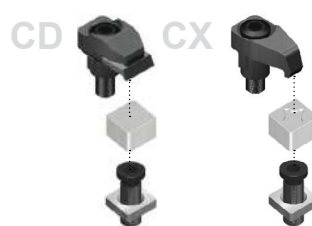
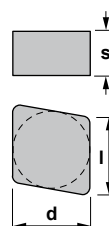

### CNGN



### CNGX





**Caratteristiche:**

Portautensili per operazioni di profilatura interna, montano inserti romboidali negativi bifacciali (angolo 55°).

Per applicazioni generali, sgrossatura, semi-finitura e finitura.

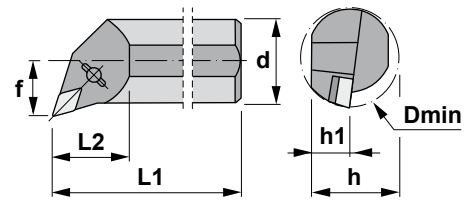

**Características:**

Barra de mandrinar de copiado equipada con plaquita rómbica negativa de doble cara (ángulo 55°).

Para aplicaciones generales, desbaste, semiacabados y acabados.

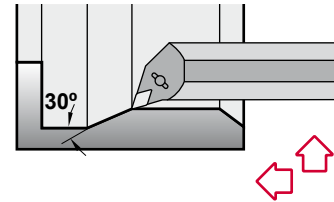

## CDQN 107°30'

Riferimento Referencia	d	h1	L1	L2	f	h	Dmin	Dimensioni inserto Medida plaquita	KG
S32S CDQN R/L 12-7CD	32	15,0	250	40	22	30	50	DNGN 1207..	1,450
S40T CDQN R/L 12-4CD	40	18,5	300	35	27	37	70	DNGN 1204..	2,700
S40T CDQN R/L 12-7CD	40	18,5	300	35	27	37	70	DNGN 1207..	2,700
S50U CDQN R/L 15-CD	50	23,5	350	38	32	47	70	DNGN 1507..	4,950
S32S CDQN R/L 12-7CX	32	15,0	250	40	22	30	50	DNGX 1207..	1,450
S40T CDQN R/L 12-4CX	40	18,5	300	35	27	37	70	DNGX 1204..	2,700
S40T CDQN R/L 12-7CX	40	18,5	300	35	27	37	70	DNGX 1207..	2,700
S50U CDQN R/L 15-CX	50	23,5	350	38	32	47	70	DNGX 1507..	4,950

Riferimento Referencia							Nm
S32S CDQN R/L 12-7CD	-	-	9414	2413	-	5004	3.5
S40T CDQN R/L 12-4CD	IDSN 354	1151	9414	2413	-	5004	3.5
S40T CDQN R/L 12-7CD	IDSN 334	1151	9414	2413	-	5004	3.5
S50U CDQN R/L 15-CD	IDSN 432	1160	9414	2417	-	5004	3.5
S32S CDQN R/L 12-7CX	-	-	-	-	2415	5004	3.5
S40T CDQN R/L 12-4CX	IDSN 354	1151	-	-	2415	5004	3.5
S40T CDQN R/L 12-7CX	IDSN 334	1151	-	-	2415	5004	3.5
S50U CDQN R/L 15-CX	IDSN 432	1160	-	-	2432	5004	3.5

### DNG..

Inserti romboidali negativi 55°  
Plaquetas rómbicas negativas 55° D03-04

Riferimento / Ref.	l	s	d
DNG.. 1204..	12,20	4,76	10,00
DNG.. 1207..	12,20	7,94	10,00
DNG.. 1507..	15,50	7,94	12,70

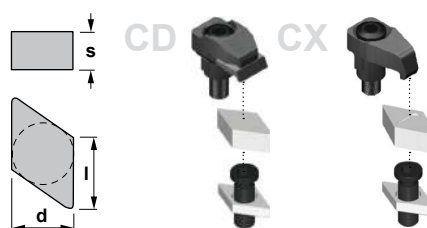

### DNGN



### DNGX





**Caratteristiche:**

Portautensili per operazioni di profilatura interna, montano inserti romboidali negativi bifacciali (angolo 55°).

Per applicazioni generali, sgrossatura, semi-finitura e finitura.

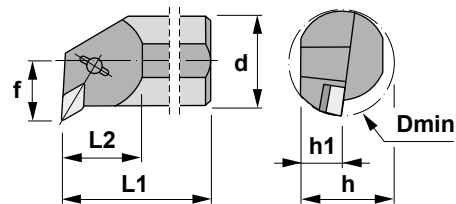

**Características:**

Barra de mandrinar de copiado equipada con plaquita rómbrica negativa de doble cara (ángulo 55°).

Para aplicaciones generales, desbaste, semiacabados y acabados.

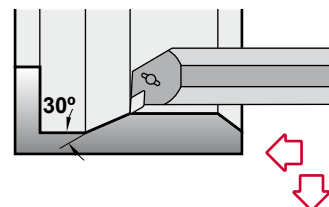

## CDUN 93°

Riferimento Referencia	d	h1	L1	L2	f	h	Dmin	Dimensioni inserto Medida plaquita	
S32S CDUN R/L 12-7CD	32	15,0	250	40	22	30	40	DNGN 1207..	1,450
S40T CDUN R/L 12-4CD	40	18,5	300	50	27	37	70	DNGN 1204..	2,700
S40T CDUN R/L 12-7CD	40	18,5	300	50	27	37	70	DNGN 1207..	2,700
S50U CDUN R/L 15-CD	50	23,5	350	50	32	47	70	DNGN 1507..	4,950
S32S CDUN R/L 12-7CX	32	15,0	250	40	22	30	40	DNGX 1207..	1,450
S40T CDUN R/L 12-4CX	40	18,5	300	50	27	37	70	DNGX 1204..	2,700
S40T CDUN R/L 12-7CX	40	18,5	300	50	27	37	70	DNGX 1207..	2,700
S50U CDUN R/L 15-CX	50	23,5	350	50	32	47	70	DNGX 1507..	4,950

Riferimento Referencia							Nm
S32S CDUN R/L 12-7CD	-	-	9416	2413	-	5004	3.5
S40T CDUN R/L 12-4CD	IDSN 354	1151	9416	2413	-	5004	3.5
S40T CDUN R/L 12-7CD	IDSN 334	1151	9416	2413	-	5004	3.5
S50U CDUN R/L 15-CD	IDSN 432	1160	9416	2417	-	5004	3.5
S32S CDUN R/L 12-7CX	-	-	-	-	2415	5004	3.5
S40T CDUN R/L 12-4CX	IDSN 354	1151	-	-	2415	5004	3.5
S40T CDUN R/L 12-7CX	IDSN 334	1151	-	-	2415	5004	3.5
S50U CDUN R/L 15-CX	IDSN 432	1160	-	-	2432	5004	3.5

### DNG..

Inserti romboidali negativi 55°  
Plaquetas rómbricas negativas 55° D03-04

Riferimento / Ref.	l	s	d
DNG.. 1204..	12,20	4,76	10,00
DNG.. 1207..	12,20	7,94	10,00
DNG.. 1507..	15,50	7,94	12,70

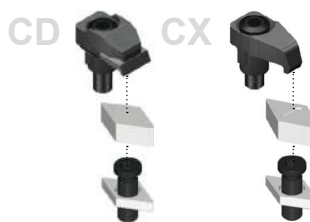
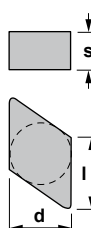

#### DNGN



#### DNGX

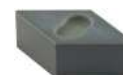



**Caratteristiche:**

Portautensili per molteplici operazioni di tornitura interna, montano inserti romboidali negativi bifacciali (angolo 75°).  
Per applicazioni generali, sgrossatura, semi-finitura e finitura.

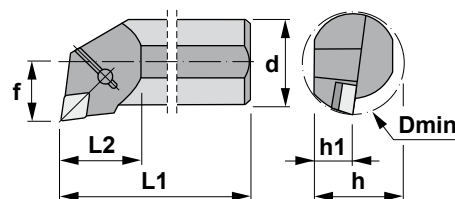

**Características:**

Barra de mandrinar multifunción equipada con plaquita rómbica negativa de doble cara (ángulo 75°).  
Para aplicaciones generales, desbaste, semiacabados y acabados.

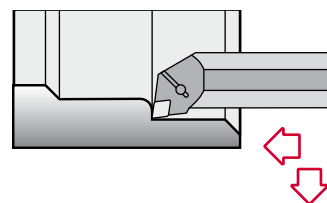

## CELN 97°30'

Riferimento Referencia	d	h1	L1	L2	f	h	Dmin	Dimensioni inserto Medida plaquita	Kg
S40T CELN R/L 13-CD	40	18,5	300	32	27	37	50	ENGN 1307..	2,700
S50U CELN R/L 13-CD	50	23,5	350	32	35	47	63	ENGN 1307..	4,950

Riferimento Referencia						Nm
S40T CELN R/L 13-CD	IESN 432	1161	9414	2417	5004	3.5
S50U CELN R/L 13-CD	IESN 432	1160	9414	2417	5004	3.5

ENGN			Inserto romboidale negativo 75°. Plaquita rómbica negativa 75°.  D04			CD		ENGN	
Riferimento / Ref.	l	s	d						
ENGN 1307..	13,12	7,94	12,70						





**Caratteristiche:**

Portautensili per operazioni di tornitura interna, montano inserti quadrati negativi. Per applicazioni generali, sgrossatura, semi-finitura e finitura.

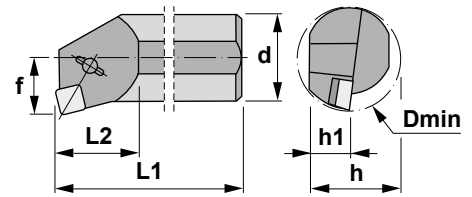

**Características:**

Barra de mandrinar para aplicaciones de torneado interior equipada con plaquita cuadrada negativa.

Para aplicaciones generales, desbaste, semiacabados y acabados.

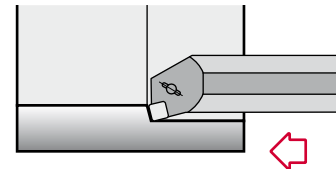

## CSKN 75°

Riferimento Referencia	d	h1	L1	L2	f	h	Dmin	Dimensioni inserto Medida plaquita	Kg
S32S CSKN R/L 12-7CD	32	15,0	250	40	22	30	40	SNGN 1207..	1,450
S40T CSKN R/L 12-4CD	40	18,5	300	67	27	37	70	SNGN 1204..	2,700
S40T CSKN R/L 12-7CD	40	18,5	300	67	27	37	70	SNGN 1207..	2,700
S50U CSKN R/L 12-4CD	50	23,5	350	67	35	47	70	SNGN 1204..	4,950
S50U CSKN R/L 12-7CD	50	23,5	350	67	35	47	70	SNGN 1207..	4,950
S32S CSKN R/L 12-7CX	32	15,0	250	40	22	30	40	SNGX 1207..	1,450
S40T CSKN R/L 12-4CX	40	18,5	300	67	27	37	70	SNGX 1204..	2,700
S40T CSKN R/L 12-7CX	40	18,5	300	67	27	37	70	SNGX 1207..	2,700
S50U CSKN R/L 12-4CX	50	23,5	350	67	35	47	70	SNGX 1204..	4,950
S50U CSKN R/L 12-7CX	50	23,5	350	67	35	47	70	SNGX 1207..	4,950

Riferimento Referencia							Nm
S32S CSKN R/L 12-7CD	-	-	9414	2417	-	5004	3.5
S40T CSKN R/L 12-4CD	ISSN 454	1161	9414	2417	-	5004	3.5
S40T CSKN R/L 12-7CD	ISSN 434	1161	9414	2417	-	5004	3.5
S50U CSKN R/L 12-4CD	ISSN 454	1160	9414	2417	-	5004	3.5
S50U CSKN R/L 12-7CD	ISSN 434	1160	9414	2417	-	5004	3.5
S32S CSKN R/L 12-7CX	-	-	-	-	2415	5004	3.5
S40T CSKN R/L 12-4CX	ISSN 454	1161	-	-	2415	5004	3.5
S40T CSKN R/L 12-7CX	ISSN 434	1161	-	-	2415	5004	3.5
S50U CSKN R/L 12-4CX	ISSN 454	1160	-	-	2415	5004	3.5
S50U CSKN R/L 12-7CX	ISSN 434	1160	-	-	2415	5004	3.5

### SNG..

Inserti quadrati negativi. D05-06  
Plaquetas cuadradas negativas.

Riferimento / Ref.	l	s	d
SNG.. 1204..	12,70	4,76	12,70
SNG.. 1207..	12,70	7,94	12,70

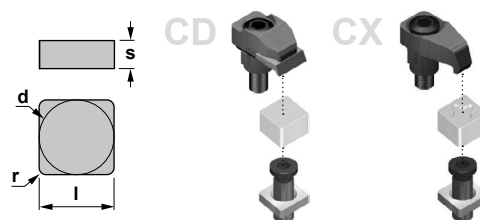

### SNGN



### SNGX





**Caratteristiche:**

Portautensili per operazioni di tornitura e spallamenti interni, montano inserti quadrati negativi.

Per applicazioni generali, sgrossatura, semi-finitura e finitura.

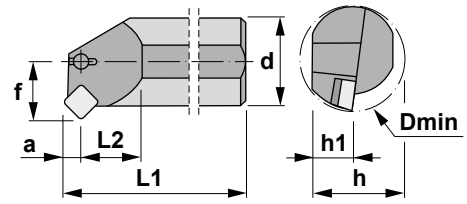

**Características:**

Barra de mandrinar para aplicaciones de torneado interior y achaflanado equipada con plaquita cuadrada negativa.

Para aplicaciones generales, desbaste, semiacabados y acabados.

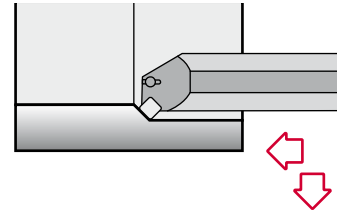

## CSSN 45°

Riferimento Referencia	d	h1	L1	L2	f	h	Dmin	Dimensioni inserto Medida plaquita	Kg
S32S CSSN R/L 12-7CD	32	15,0	250	40	22	30	40	SNGN 1207..	1,450
S40T CSSN R/L 12-4CD	40	18,5	300	50	27	37	70	SNGN 1204..	2,700
S40T CSSN R/L 12-7CD	40	18,5	300	50	27	37	70	SNGN 1207..	2,700
S50U CSSN R/L 15-CD	50	23,5	350	50	32	47	70	SNGN 1507..	4,950
S32S CSSN R/L 12-7CX	32	15,0	250	40	22	30	40	SNGX 1207..	1,450
S40T CSSN R/L 12-4CX	40	18,5	300	50	27	37	70	SNGX 1204..	2,700
S40T CSSN R/L 12-7CX	40	18,5	300	50	27	37	70	SNGX 1207..	2,700
S50U CSSN R/L 15-CX	50	23,5	350	50	32	47	70	SNGX 1507..	4,950

Riferimento Referencia							Nm
S32S CSSN R/L 12-7CD	-	-	9414	2417	-	5004	3.5
S40T CSSN R/L 12-4CD	ISSN 454	1161	9414	2417	-	5004	3.5
S40T CSSN R/L 12-7CD	ISSN 434	1161	9414	2417	-	5004	3.5
S50U CSSN R/L 15-CD	ISSN 534	1180	9414	2417	-	5004	3.5
S32S CSSN R/L 12-7CX	-	-	-	-	2415	5004	3.5
S40T CSSN R/L 12-4CX	ISSN 454	1161	-	-	2415	5004	3.5
S40T CSSN R/L 12-7CX	ISSN 434	1161	-	-	2415	5004	3.5
S50U CSSN R/L 15-CX	ISSN 534	1180	-	-	2415	5004	3.5

### SNG..

Inserti quadrati negativi. D05-06  
Plaquetas cuadradas negativas.

Riferimento / Ref.	l	s	d
SNG.. 1204..	12,70	4,76	12,70
SNG.. 1207..	12,70	7,94	12,70
SNG.. 1507..	15,87	7,94	15,87

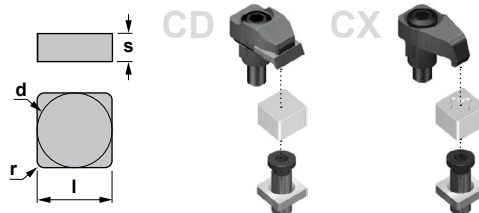

### SNGN



### SNGX





**Caratteristiche:**

Portautensili per operazioni di tornitura interna, montano inserti quadrati negativi. Per applicazioni generali, sgrossatura, semi-finitura e finitura.

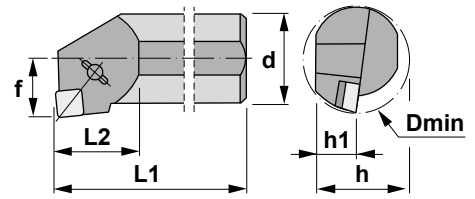

**Características:**

Barra de mandrinar para aplicaciones de torneado interior equipada con plaquita cuadrada negativa.

Para aplicaciones generales, desbaste, semiacabados y acabados.

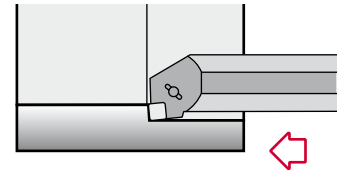

## CSYN 85°

Riferimento Referencia	d	h1	L1	L2	f	h	Dmin	Dimensioni inserto Medida plaquita	KG
S32S CSYN R/L 12-7CD	32	15,0	250	40	22	30	40	SNGN 1207..	1,450
S40T CSYN R/L 12-4CD	40	18,5	300	67	27	37	70	SNGN 1204..	2,700
S40T CSYN R/L 12-7CD	40	18,5	300	67	27	37	70	SNGN 1207..	2,700
S50U CSYN R/L 12-4CD	50	23,5	350	67	35	47	70	SNGN 1204..	4,950
S50U CSYN R/L 12-7CD	50	23,5	350	67	35	47	70	SNGN 1207..	4,950
S32S CSYN R/L 12-7CX	32	15,0	250	40	22	30	40	SNGX 1207..	1,450
S40T CSYN R/L 12-4CX	40	18,5	300	67	27	37	70	SNGX 1204..	2,700
S40T CSYN R/L 12-7CX	40	18,5	300	67	27	37	70	SNGX 1207..	2,700
S50U CSYN R/L 12-4CX	50	23,5	350	67	35	47	70	SNGX 1204..	4,950
S50U CSYN R/L 12-7CX	50	23,5	350	67	35	47	70	SNGX 1207..	4,950

Riferimento Referencia							Nm
S32S CSYN R/L 12-7CD	-	-	9414	2417	-	5004	3.5
S40T CSYN R/L 12-4CD	ISSN 454	1161	9414	2417	-	5004	3.5
S40T CSYN R/L 12-7CD	ISSN 434	1161	9414	2417	-	5004	3.5
S50U CSYN R/L 12-4CD	ISSN 454	1160	9414	2417	-	5004	3.5
S50U CSYN R/L 12-7CD	ISSN 434	1160	9414	2417	-	5004	3.5
S32S CSYN R/L 12-7CX	-	-	-	-	2415	5004	3.5
S40T CSYN R/L 12-4CX	ISSN 454	1161	-	-	2415	5004	3.5
S40T CSYN R/L 12-7CX	ISSN 434	1161	-	-	2415	5004	3.5
S50U CSYN R/L 12-4CX	ISSN 454	1160	-	-	2415	5004	3.5
S50U CSYN R/L 12-7CX	ISSN 434	1160	-	-	2415	5004	3.5

### SNG..

Inserti quadrati negativi.  
Plaquetas cuadradas negativas. D05-06

Riferimento / Ref.	l	s	d
SNG.. 1204..	12,70	4,76	12,70
SNG.. 1207..	12,70	7,94	12,70

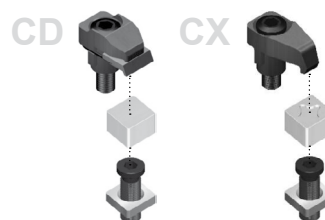
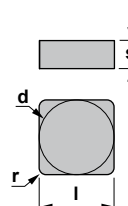

### SNGN



### SNGX



**(C) Staffa superiore / Brida superior**

Questo classico sistema di fissaggio è stato disegnato per fissare inserti di ceramica piani negativi, sia con rompitrucolo sinterizzato che addizionale.

Este clásico sistema de fijación está diseñado para sujetar plaquitas de cerámica negativas, tanto si tienen rompevirutas incorporado como adicional.

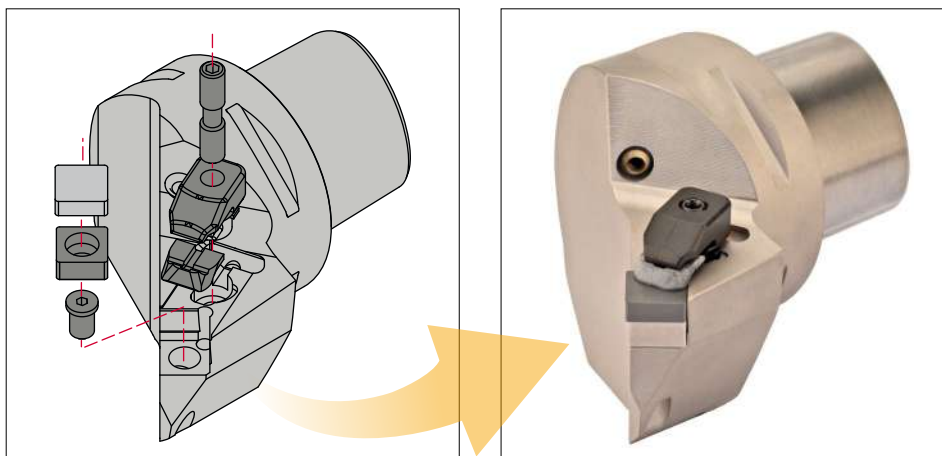

**Tutti i tipi di staffa  
 sullo stesso utensile.**

**Todos los tipos de brida  
 en la misma herramienta.**



**Staffa superiore  
 Brida superior**

**C**

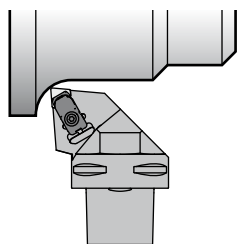

**Dimple Lock**

**D**

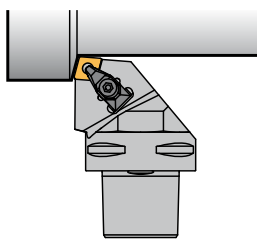

**Doppio bloccaggio  
 Doble fijación**

**M**

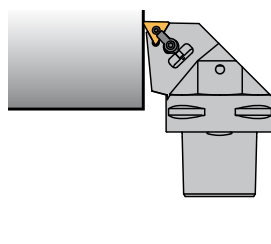



**Caratteristiche:**

Portautensili per operazioni esterne di sfacciatura, montano inserti romboidali negativi (angolo 80°).  
PSC con refrigerazione interna.

- 1)  $\gamma$  = Angolo di spoglia (valido con un inserto piano).
- 2)  $\lambda.s$  = Angolo d'inclinazione.

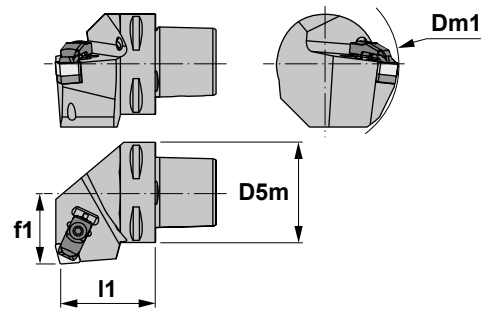

**Características:**

Portaherramientas para refrentar equipado con plaquita rómbica negativa (ángulo 80°).  
PSC con refrigeración interior.

- 1)  $\gamma$  = Ángulo de desprendimiento (válido para plaquitas planas).
- 2)  $\lambda.s$  = Ángulo de inclinación.

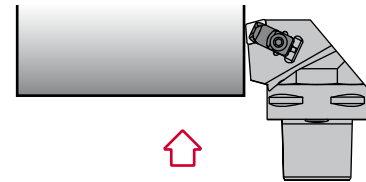

## CCKN 75°

Riferimento Referencia	D5m	Dm1 min.	f1	l1	$\gamma^1$	$\lambda.s^2$	Dimensioni inserto Medida plaquita	kg
PSC40-CCKNR/L27050-12-4	40	110	27	50	-6°	-6°	CNGN 1204..	0,420
PSC40-CCKNR/L27050-12-7	40	110	27	50	-6°	-6°	CNGN 1207..	0,420
PSC50-CCKNR/L35060-12-4	50	110	35	60	-6°	-6°	CNGN 1204..	0,800
PSC50-CCKNR/L35060-12-7	50	110	35	60	-6°	-6°	CNGN 1207..	0,800
PSC63-CCKNR/L45065-12-4	63	110	45	65	-6°	-6°	CNGN 1204..	1,100
PSC63-CCKNR/L45065-12-7	63	110	45	65	-6°	-6°	CNGN 1207..	1,100
PSC40-CCKNR/L27050-16	40	125	27	50	-6°	-6°	CNGN 1607..	0,420
PSC50-CCKNR/L35060-16	50	125	35	60	-6°	-6°	CNGN 1607..	0,800
PSC63-CCKNR/L45065-16	63	125	45	65	-6°	-6°	CNGN 1607..	1,100
PSC63-CCKNR/L45065-19	63	125	45	65	-6°	-6°	CNGN 1907..	1,100
PSC80-CCKNR/L55080-19	80	125	55	80	-6°	-6°	CNGN 1907..	2,740

Riferimento Referencia							Nm
PSC40-CCKNR/L27050-12-4	1766	ICSN-442	9414	2713	1086	5003	3.0
PSC40-CCKNR/L27050-12-7	1766	ICSN-422	9414	2713	1086	5003	3.0
PSC50-CCKNR/L35060-12-4	1766	ICSN-442	9414	2713	1086	5003	3.0
PSC50-CCKNR/L35060-12-7	1766	ICSN-422	9414	2713	1086	5003	3.0
PSC63-CCKNR/L45065-12-4	1766	ICSN-442	9414	2713	1086	5003	3.0
PSC63-CCKNR/L45065-12-7	1766	ICSN-422	9414	2713	1086	5003	3.0
PSC40-CCKNR/L27050-16	1768	ICSN-523	9414	2713	1086	5003	3.0
PSC50-CCKNR/L35060-16	1768	ICSN-523	9414	2713	1086	5003	3.0
PSC63-CCKNR/L45065-16	1768	ICSN-523	9414	2713	1086	5003	3.0
PSC63-CCKNR/L45065-19	1770	ICSN-623	9414	2713	1086	5003	3.0
PSC80-CCKNR/L55080-19	1770	ICSN-623	9414	2713	1086	5003	3.0

### CNGN

Inserto romboidale negativo 80°. D03  
Plaquita rómbica negativa 80°.

Riferimento / Ref.	l	s	d
CNGN 1204..	12,90	4,76	12,70
CNGN 1207..	12,90	7,94	12,70
CNGN 1607..	16,10	7,94	15,88
CNGN 1907..	19,30	7,94	19,05

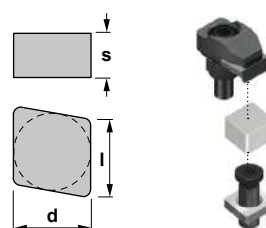



**Caratteristiche:**  
Portautensili per molteplici operazioni di tornitura esterna, montano inserti romboidali negativi bifacciali (angolo 80°). PSC con refrigerazione interna.

- 1)  $\gamma$  = Angolo di spoglia (valido con un inserto piano).  
2)  $\lambda_s$  = Angolo d'inclinazione.

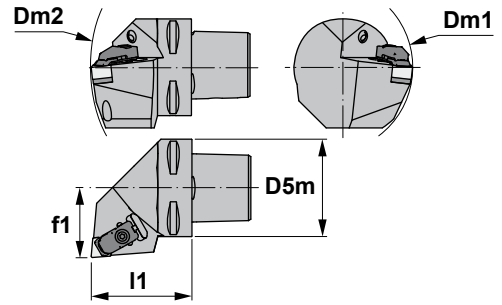

**Características:**  
Portaherramientas multifunción equipado con plaquita rómbica negativa de doble cara (ángulo 80°). PSC con refrigeración interior.

- 1)  $\gamma$  = Ángulo de desprendimiento (válido para plaquitas planas).  
2)  $\lambda_s$  = Ángulo de inclinación.

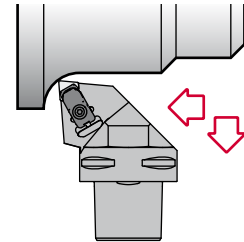

## CCLN 95°

Riferimento Referencia	D5m	Dm1 min.	Dm2 min.	f1	l1	$\gamma^1$	$\lambda_s^2$	Dimensioni inserto Medida plaquita	KG
PSC40-CCLNR/L27050-12-4	40	110	140	27	50	-6°	-6°	CNGN 1204..	0,420
PSC40-CCLNR/L27050-12-7	40	110	140	27	50	-6°	-6°	CNGN 1207..	0,420
PSC50-CCLNR/L35060-12-4	50	110	165	35	60	-6°	-6°	CNGN 1204..	0,800
PSC50-CCLNR/L35060-12-7	50	110	165	35	60	-6°	-6°	CNGN 1207..	0,800
PSC63-CCLNR/L45065-12-4	63	110	190	45	65	-6°	-6°	CNGN 1204..	1,100
PSC63-CCLNR/L45065-12-7	63	110	190	45	65	-6°	-6°	CNGN 1207..	1,100
PSC63-CCLNR/L45065-16	63	125	190	45	65	-6°	-6°	CNGN 1607..	1,100
PSC80-CCLNR/L55080-16	80	125	250	55	80	-6°	-6°	CNGN 1607..	2,740

Riferimento Referencia							Nm
PSC40-CCLNR/L27050-12-4	1766	ICSN-442	9414	2713	1086	5003	3.0
PSC40-CCLNR/L27050-12-7	1766	ICSN-422	9414	2713	1086	5003	3.0
PSC50-CCLNR/L35060-12-4	1766	ICSN-442	9414	2713	1086	5003	3.0
PSC50-CCLNR/L35060-12-7	1766	ICSN-422	9414	2713	1086	5003	3.0
PSC63-CCLNR/L45065-12-4	1766	ICSN-442	9414	2713	1086	5003	3.0
PSC63-CCLNR/L45065-12-7	1766	ICSN-422	9414	2713	1086	5003	3.0
PSC63-CCLNR/L45065-16	1768	ICSN-523	9414	2713	1086	5003	3.0
PSC80-CCLNR/L55080-16	1768	ICSN-523	9414	2713	1086	5003	3.0

### CNGN

Inserto romboidale negativo 80°.  
Plaquita rómbica negativa 80°.  D03

Riferimento / Ref.	l	s	d
CNGN 1204..	12,90	4,76	12,70
CNGN 1207..	12,90	7,94	12,70
CNGN 1607..	16,10	7,94	15,88
CNGN 1907..	19,30	7,94	19,05

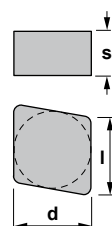

### CNGN





**Caratteristiche:**

Portautensili per molteplici operazioni di tornitura esterna, montano inserti romboidali negativi bifacciali (angolo 80°). PSC con refrigerazione interna.

- 1)  $\gamma$  = Angolo di spoglia (valido con un inserto piano).
- 2)  $\lambda_s$  = Angolo d'inclinazione.

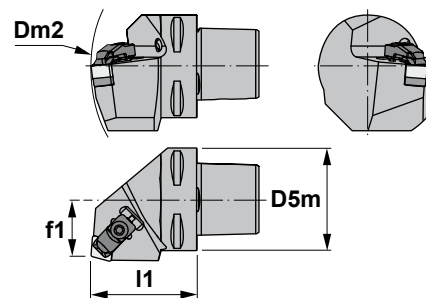

**Características:**

Portaherramientas multifunción equipado con plaquita rómbica negativa de doble cara (ángulo 80°). PSC con refrigeración interior.

- 1)  $\gamma$  = Ángulo de desprendimiento (válido para plaquitas planas).
- 2)  $\lambda_s$  = Ángulo de inclinación.

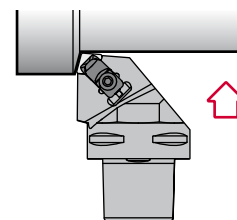

## CCRN 75°

Riferimento Referencia	D5m	Dm2 min.	f1	l1	$\gamma^1$	$\lambda_s^2$	Dimensioni inserto Medida plaquita	Kg
PSC40-CCRN/L22050-12-4	40	140	22	50	-6°	-6°	CNGN 1204..	0,420
PSC40-CCRN/L22050-12-7	40	140	22	50	-6°	-6°	CNGN 1207..	0,420
PSC50-CCRN/L27060-12-4	50	165	27	60	-6°	-6°	CNGN 1204..	0,800
PSC50-CCRN/L27060-12-7	50	165	27	60	-6°	-6°	CNGN 1207..	0,800
PSC63-CCRN/L35065-12-4	63	190	35	65	-6°	-6°	CNGN 1204..	1,400
PSC63-CCRN/L35065-12-7	63	190	35	65	-6°	-6°	CNGN 1207..	1,400
PSC50-CCRN/L27060-16	50	165	27	60	-6°	-6°	CNGN 1607..	0,800
PSC63-CCRN/L35065-16	63	190	35	65	-6°	-6°	CNGN 1607..	1,400
PSC80-CCRN/L55080-16	80	250	55	80	-6°	-6°	CNGN 1607..	2,740
PSC50-CCRN/L27060-19	50	165	27	60	-6°	-6°	CNGN 1907..	0,800
PSC63-CCRN/L35065-19	63	190	35	65	-6°	-6°	CNGN 1907..	1,400
PSC80-CCRN/L55080-19	80	250	55	80	-6°	-6°	CNGN 1907..	2,740

Riferimento Referencia							Nm
PSC40-CCRN/L22050-12-4	1766	ICSN-442	9414	2713	1086	5003	3.0
PSC40-CCRN/L22050-12-7	1766	ICSN-422	9414	2713	1086	5003	3.0
PSC50-CCRN/L27060-12-4	1766	ICSN-442	9414	2713	1086	5003	3.0
PSC50-CCRN/L27060-12-7	1766	ICSN-422	9414	2713	1086	5003	3.0
PSC63-CCRN/L35065-12-4	1766	ICSN-442	9414	2713	1086	5003	3.0
PSC63-CCRN/L35065-12-7	1766	ICSN-422	9414	2713	1086	5003	3.0
PSC50-CCRN/L27060-16	1768	ICSN-523	9414	2713	1086	5003	3.0
PSC63-CCRN/L35065-16	1768	ICSN-523	9414	2713	1086	5003	3.0
PSC80-CCRN/L55080-16	1768	ICSN-523	9414	2713	1086	5003	3.0
PSC50-CCRN/L27060-19	1770	ICSN-623	9414	2713	1086	5003	3.0
PSC63-CCRN/L35065-19	1770	ICSN-623	9414	2713	1086	5003	3.0
PSC80-CCRN/L55080-19	1770	ICSN-623	9414	2713	1086	5003	3.0

### CNGN

Inserto romboidale negativo 80°.  
Plaquita rómbica negativa 80°. D03

Riferimento / Ref.	l	s	d
CNGN 1204..	12,90	4,76	12,70
CNGN 1207..	12,90	7,94	12,70
CNGN 1607..	16,10	7,94	15,88
CNGN 1907..	19,30	7,94	19,05

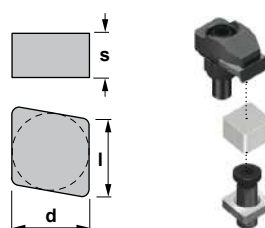

### CNGN





**Caratteristiche:**

Portautensili per operazioni di tornitura e profilatura esterne, montano inserti romboidali negativi bifacciali (angolo 55°). PSC con refrigerazione interna.

- 1)  $\gamma$  = Angolo di spoglia (valido con un inserto piano).
- 2)  $\lambda_s$  = Angolo d'inclinazione.

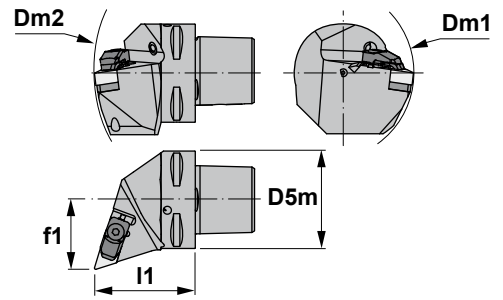

**Características:**

Portaherramientas de torneado exterior y copiado con plaquita rómbica negativa de doble cara (ángulo 55°). PSC con refrigeración interior.

- 1)  $\gamma$  = Ángulo de desprendimiento (válido para plaquitas planas).
- 2)  $\lambda_s$  = Ángulo de inclinación.

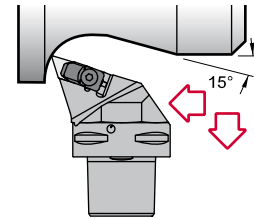

## CDHN 107° 30'

Riferimento Referencia	D5m	Dm1 min.	Dm2 min.	f1	l1	$\gamma$ 1)	$\lambda_s$ 2)	Dimensioni inserto Medida plaquita	
PSC40-CDHNR/L27055-15	40	110	145	27	50	-6°	-7°	DNGN 1507..	0,430
PSC50-CDHNR/L35060-15	50	110	165	35	60	-6°	-7°	DNGN 1507..	0,800
PSC63-CDHNR/L45065-15	63	110	190	45	65	-6°	-7°	DNGN 1507..	1,100
PSC80-CDHNR/L55080-15	80	110	250	55	80	-6°	-7°	DNGN 1507..	2,740

Riferimento Referencia							Nm
PSC40-CDHNR/L27055-15	1766	IDSN-422	9416	2717	1086	5003	3.0
PSC50-CDHNR/L35060-15	1766	IDSN-422	9416	2717	1086	5003	3.0
PSC63-CDHNR/L45065-15	1766	IDSN-422	9416	2717	1086	5003	3.0
PSC80-CDHNR/L55080-15	1766	IDSN-422	9416	2717	1086	5003	3.0

### DNGN

Inserto romboidale negativo 55°.  
Plaquita rómbica negativa 55°. D03

Riferimento / Ref.	l	s	d
DNGN 1507..	15,50	7,94	12,70

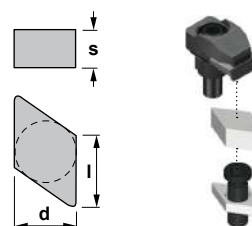

### DNGN





**Caratteristiche:**

Portautensili per operazioni di tornitura e profilatura esterne, montano inserti romboidali negativi bifacciali (angolo 55°).

PSC con refrigerazione interna.

- 1)  $\gamma$  = Angolo di spoglia (valido con un inserto piano).
- 2)  $\lambda_s$  = Angolo d'inclinazione.

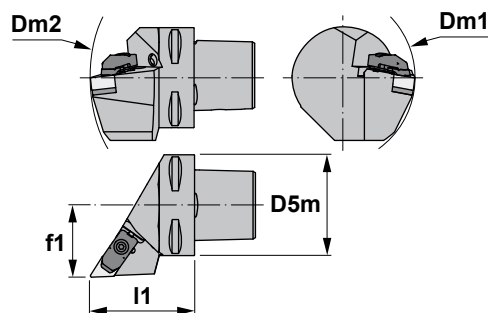

**Características:**

Portaherramientas de torneado exterior y copiado equipado con plaquita rómbica negativa de doble cara (ángulo 55°).

PSC con refrigeración interior.

- 1)  $\gamma$  = Ángulo de desprendimiento (válido para plaquitas planas).
- 2)  $\lambda_s$  = Ángulo de inclinación.

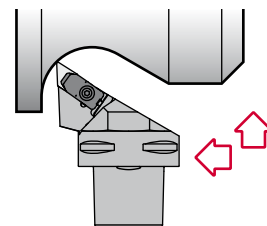

## CDJN 93°

Riferimento Referencia	D5m	Dm1 min.	Dm2 min.	f1	l1	$\gamma$ 1)	$\lambda_s$ 2)	Dimensioni inserto Medida plaquita	KG
PSC40-CDJNR/L27055-15	40	110	145	27	50	-6°	-7°	DNGN 1507..	0,430
PSC50-CDJNR/L35060-15	50	110	165	35	60	-6°	-7°	DNGN 1507..	0,800
PSC63-CDJNR/L45065-15	63	110	190	45	65	-6°	-7°	DNGN 1507..	1,100
PSC80-CDJNR/L55080-15	80	110	250	55	80	-6°	-7°	DNGN 1507..	2,740

Riferimento Referencia							Nm
PSC40-CDJNR/L27055-15	1766	IDSN-422	9416	2717	1086	5003	3.0
PSC50-CDJNR/L35060-15	1766	IDSN-422	9416	2717	1086	5003	3.0
PSC63-CDJNR/L45065-15	1766	IDSN-422	9416	2717	1086	5003	3.0
PSC80-CDJNR/L55080-15	1766	IDSN-422	9416	2717	1086	5003	3.0

### DNGN

Inserto romboidale negativo 55°.  
Plaquita rómbica negativa 55°. D03

Riferimento / Ref.	l	s	d
DNGN 1507..	15,50	7,94	12,70

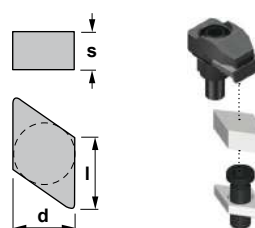

### DNGN





**Caratteristiche:**

Portautensili per operazioni di tornitura e profilatura esterne, montano inserti romboidali negativi bifacciali (angolo 55°).  
PSC con refrigerazione interna.

- 1)  $\gamma$  = Angolo di spoglia (valido con un inserto piano).
- 2)  $\lambda_s$  = Angolo d'inclinazione.

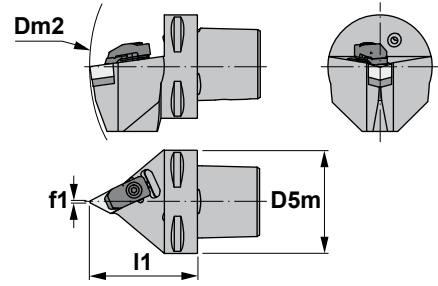

**Características:**

Portaherramientas para aplicaciones de torneado exterior y copiado equipado con plaquita rómbica negativa de doble cara (ángulo 55°).  
PSC con refrigeración interior.

- 1)  $\gamma$  = Ángulo de desprendimiento (válido para plaquitas planas).
- 2)  $\lambda_s$  = Ángulo de inclinación.

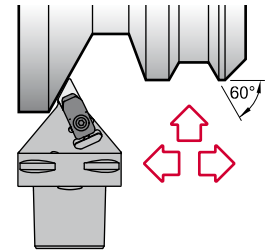

## CDNN 63°

Riferimento Referencia	D5m	Dm2 min.	f1	l1	$\gamma$ 1)	$\lambda_s$ 2)	Dimensioni inserto Medida plaquita	KG
PSC40-CDNNN00055-15	40	145	0.5	50	-5°	-9°	DNGN 1507..	0,370
PSC50-CDNNN00060-15	50	165	0.5	60	-5°	-9°	DNGN 1507..	0,750
PSC63-CDNNN00065-15	63	190	0.5	65	-5°	-9°	DNGN 1507..	1,070
PSC80-CDNNN00080-15	80	250	0.5	80	-5°	-9°	DNGN 1507..	2,320

Riferimento Referencia							Nm
PSC40-CDNNN00055-15	1766	IDSN-422	9416	2717	1086	5003	3.0
PSC50-CDNNN00060-15	1766	IDSN-422	9416	2717	1086	5003	3.0
PSC63-CDNNN00065-15	1766	IDSN-422	9416	2717	1086	5003	3.0
PSC80-CDNNN00080-15	1766	IDSN-422	9416	2717	1086	5003	3.0

DNGN				Inserto romboidale negativo 55°. Plaquita rómbica negativa 55°.		i D03		DNGN	
Riferimento / Ref.	l	s	d						
DNGN 1507..	15,50	7,94	12,70						



**Caratteristiche:**

Portautensili per operazioni di tornitura e profilatura esterne, montano inserti romboidali negativi bifacciali (angolo 55°).  
PSC con refrigerazione interna.

- 1)  $\gamma$  = Angolo di spoglia (valido con un inserto piano).
- 2)  $\lambda_s$  = Angolo d'inclinazione.

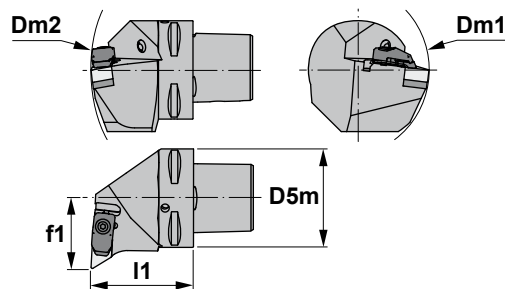

**Características:**

Portaherramientas para aplicaciones de torneado exterior y copiado equipado con plaquita rómbica negativa de doble cara (ángulo 55°).  
PSC con refrigeración interior.

- 1)  $\gamma$  = Ángulo de desprendimiento (válido para plaquitas planas).
- 2)  $\lambda_s$  = Ángulo de inclinación.

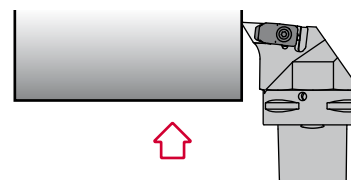

## CDUN 93°

Riferimento Referencia	D5m	Dm1 min.	Dm2 min.	f1	l1	$\gamma^1$	$\lambda_s^2$	Dimensioni inserto Medida plaquita	Kg
PSC40-CDUNR/L27050-15	40	110	140	27	50	-6°	-7°	DNGN 1507..	0,420
PSC50-CDUNR/L35060-15	50	110	165	35	60	-6°	-7°	DNGN 1507..	0,800
PSC63-CDUNR/L45065-15	63	110	190	45	65	-6°	-7°	DNGN 1507..	1,100
PSC80-CDUNR/L55080-15	80	110	250	55	80	-6°	-7°	DNGN 1507..	2,740

Riferimento Referencia							Nm
PSC40-CDUNR/L27050-15	1766	IDSN-422	9416	2717	1086	5003	3.0
PSC50-CDUNR/L35060-15	1766	IDSN-422	9416	2717	1086	5003	3.0
PSC63-CDUNR/L45065-15	1766	IDSN-422	9416	2717	1086	5003	3.0
PSC80-CDUNR/L55080-15	1766	IDSN-422	9416	2717	1086	5003	3.0

### DNGN

Inserto romboidale negativo 55°.  
Plaquita rómbica negativa 55° D03

Riferimento / Ref.	l	s	d
DNGN 1507..	15,50	7,94	12,70

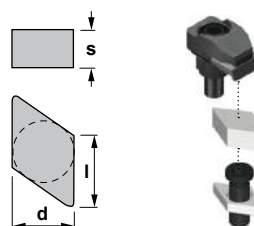

### DNGN





**Caratteristiche:**

Portautensili per molteplici operazioni di profilatura esterna, montano inserti rotondi negativi.  
PSC con refrigerazione interna.

- 1)  $\gamma$  = Angolo di spoglia (valido con un inserto piano).
- 2)  $\lambda_s$  = Angolo d'inclinazione.

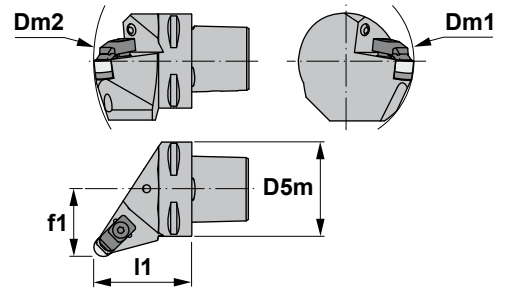

**Características:**

Portaherramientas multifunción de copiado equipado con plaquita redonda negativa.  
PSC con refrigeración interior.

- 1)  $\gamma$  = Ángulo de desprendimiento (válido para plaquitas planas).
- 2)  $\lambda_s$  = Ángulo de inclinación.

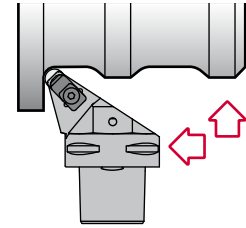

## CRSN

Riferimento Referencia	D5m	Dm1 min.	Dm2 min.	f1	l1	$\gamma^1$	$\lambda_s^2$	Dimensioni inserto Medida plaquita	Kg
PSC40-CRSNR/L27050-12-4	40	110	140	27	50	-6°	-6°	RNGN 1204..	0,420
PSC40-CRSNR/L27050-12-7	40	110	140	27	50	-6°	-6°	RNGN 1207..	0,420
PSC50-CRSNR/L35060-12-4	50	110	165	35	60	-6°	-6°	RNGN 1204..	0,800
PSC50-CRSNR/L35060-12-7	50	110	165	35	60	-6°	-6°	RNGN 1207..	0,800
PSC63-CRSNR/L45065-12-4	63	110	190	45	65	-6°	-6°	RNGN 1204..	1,100
PSC63-CRSNR/L45065-12-7	63	110	190	45	65	-6°	-6°	RNGN 1207..	1,100

Riferimento Referencia							Nm
PSC40-CRSNR/L27050-12-4	1766	IRSN 44	9414	2713	1086	5003	3.0
PSC40-CRSNR/L27050-12-7	1766	IRSN 42	9414	2713	1086	5003	3.0
PSC50-CRSNR/L35060-12-4	1766	IRSN 44	9414	2713	1086	5003	3.0
PSC50-CRSNR/L35060-12-7	1766	IRSN 42	9414	2713	1086	5003	3.0
PSC63-CRSNR/L45065-12-4	1766	IRSN 44	9414	2713	1086	5003	3.0
PSC63-CRSNR/L45065-12-7	1766	IRSN 42	9414	2713	1086	5003	3.0

### RNGN

Inserto rotondo negativo.  
Plaquita redonda negativa. D04

Riferimento / Ref.	s	d
RNGN 1204..	4,76	12,70
RNGN 1207..	7,94	12,70

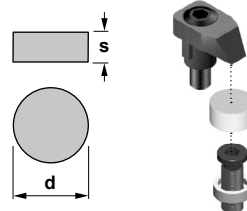

### RNGN





**Caratteristiche:**

Portautensili per applicazioni esterne di tornitura e spallamento, montano inserti quadrati negativi. PSC con refrigerazione interna.

- 1)  $\gamma$  = Angolo di spoglia (valido con un inserto piano).
- 2)  $\lambda_s$  = Angolo d'inclinazione.

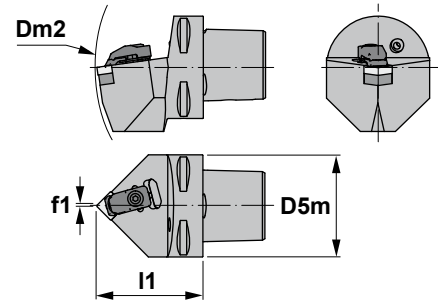

**Características:**

Portaherramientas de torneado exterior y achaflanado equipado con plaquita cuadrada negativa. PSC con refrigeración interior.

- 1)  $\gamma$  = Ángulo de desprendimiento (válido para plaquitas planas).
- 2)  $\lambda_s$  = Ángulo de inclinación.

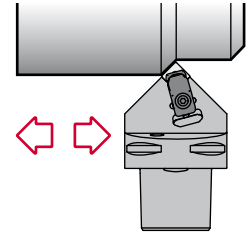

## CSDN 45°

Riferimento Referencia	D5m	Dm2 min.	f1	I1	$\gamma^1$	$\lambda_s^2$	Dimensioni inserto Medida plaquita	KG
PSC40-CSDNN00050-12-4	40	140	0.3	50	-6°	-6°	SNGN 1204..	0,350
PSC40-CSDNN00050-12-7	40	140	0.3	50	-6°	-6°	SNGN 1207..	0,350
PSC50-CSDNN00060-12-4	50	165	0.3	60	-6°	-6°	SNGN 1204..	0,750
PSC50-CSDNN00060-12-7	50	165	0.3	60	-6°	-6°	SNGN 1207..	0,750
PSC63-CSDNN00065-12-4	63	190	0.3	65	-6°	-6°	SNGN 1204..	1,070
PSC63-CSDNN00065-12-7	63	190	0.3	65	-6°	-6°	SNGN 1207..	1,070

Riferimento Referencia							Nm
PSC40-CSDNN00050-12-4	1766	ISSN-442	9414	2713	1086	5003	3.0
PSC40-CSDNN00050-12-7	1766	ISSN-422	9414	2713	1086	5003	3.0
PSC50-CSDNN00060-12-4	1766	ISSN-442	9414	2713	1086	5003	3.0
PSC50-CSDNN00060-12-7	1766	ISSN-422	9414	2713	1086	5003	3.0
PSC63-CSDNN00065-12-4	1766	ISSN-442	9414	2713	1086	5003	3.0
PSC63-CSDNN00065-12-7	1766	ISSN-422	9414	2713	1086	5003	3.0

### SNGN

Inserto quadrato negativo.  
Plaquita cuadrada negativa. **i** D05

Riferimento / Ref.	l	s	d
SNGN 1204..	12,70	4,76	12,70
SNGN 1207..	12,70	7,94	12,70

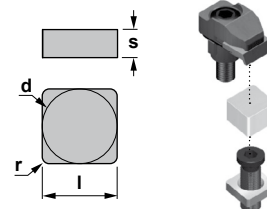

### SNGN





**Caratteristiche:**  
Portautensili per applicazioni esterne di sfacciatura, montano inserti quadrati negativi con spigoli di taglio resistenti. PSC con refrigerazione interna.

- 1)  $\gamma$  = Angolo di spoglia (valido con un inserto piano).  
2)  $\lambda.s$  = Angolo d'inclinazione.

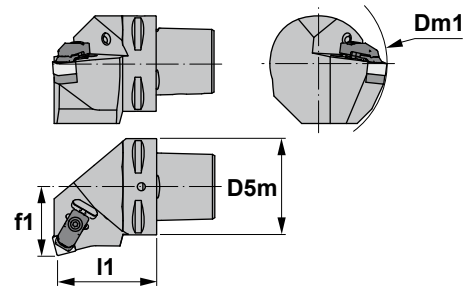

**Características:**  
Portaherramientas para aplicaciones de refrentado equipado con plaquita cuadrada negativa. PSC con refrigeración interior.

- 1)  $\gamma$  = Ángulo de desprendimiento (válido para plaquitas planas).  
2)  $\lambda.s$  = Ángulo de inclinación.

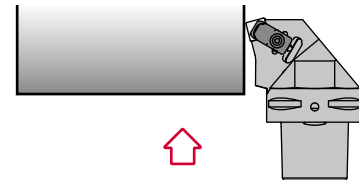

## CSKN 75°

Riferimento Referencia	D5m	Dm1 min.	f1	l1	$\gamma$ 1)	$\lambda.s$ 2)	Dimensioni inserto Medida plaquita	Kg
PSC40-CSKNR/L27050-12-4	40	110	27	50	-6°	-6°	SNGN 1204..	0,420
PSC40-CSKNR/L27050-12-7	40	110	27	50	-6°	-6°	SNGN 1207..	0,420
PSC50-CSKNR/L35060-12-4	50	110	35	60	-6°	-6°	SNGN 1204..	0,800
PSC50-CSKNR/L35060-12-7	50	110	35	60	-6°	-6°	SNGN 1207..	0,800
PSC63-CSKNR/L45065-12-4	63	110	45	65	-6°	-6°	SNGN 1204..	1,100
PSC63-CSKNR/L45065-12-7	63	110	45	65	-6°	-6°	SNGN 1207..	1,100

Riferimento Referencia							Nm
PSC40-CSKNR/L27050-12-4	1766	ISSN-442	9414	2713	1086	5003	3.0
PSC40-CSKNR/L27050-12-7	1766	ISSN-422	9414	2713	1086	5003	3.0
PSC50-CSKNR/L35060-12-4	1766	ISSN-442	9414	2713	1086	5003	3.0
PSC50-CSKNR/L35060-12-7	1766	ISSN-422	9414	2713	1086	5003	3.0
PSC63-CSKNR/L45065-12-4	1766	ISSN-442	9414	2713	1086	5003	3.0
PSC63-CSKNR/L45065-12-7	1766	ISSN-422	9414	2713	1086	5003	3.0

### SNGN

Inserto quadrato negativo.  
Plaquita cuadrada negativa. D05

Riferimento / Ref.	l	s	d
SNGN 1204..	12,70	4,76	12,70
SNGN 1207..	12,70	7,94	12,70

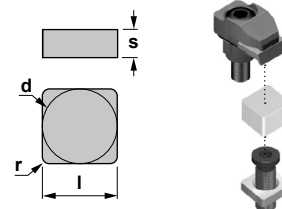

### SNGN





**Caratteristiche:**

Portautensili per applicazioni di tornitura esterna, montano inserti quadrati negativi. PSC con refrigerazione interna.

- 1)  $\gamma$  = Angolo di spoglia (valido con un inserto piano).
- 2)  $\lambda_s$  = Angolo d'inclinazione.

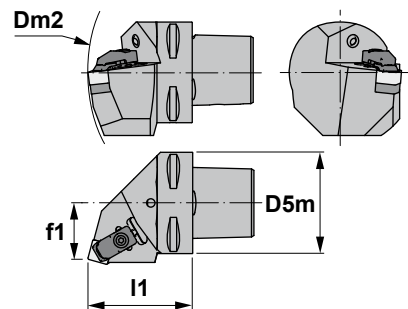

**Características:**

Portaherramientas para aplicaciones de torneado exterior equipado con plaquita cuadrada negativa. PSC con refrigeración interior.

- 1)  $\gamma$  = Ángulo de desprendimiento (válido para plaquitas planas).
- 2)  $\lambda_s$  = Ángulo de inclinación.

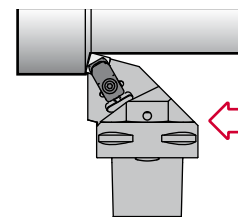

## CSRN 75°

Riferimento Referencia	D5m	Dm2 min.	f1	l1	$\gamma^{1)}$	$\lambda_s^{2)}$	Dimensioni inserto Medida plaquita	Kg
PSC40-CSRNR/L22050-12-4	40	140	22	50	-6°	-6°	SNGN 1204..	0,420
PSC40-CSRNR/L22050-12-7	40	140	22	50	-6°	-6°	SNGN 1207..	0,420
PSC50-CSRNR/L27060-12-4	50	165	27	60	-6°	-6°	SNGN 1204..	0,800
PSC50-CSRNR/L27060-12-7	50	165	27	60	-6°	-6°	SNGN 1207..	0,800
PSC63-CSRNR/L35065-12-4	63	190	35	65	-6°	-6°	SNGN 1204..	1,400
PSC63-CSRNR/L35065-12-7	63	190	35	65	-6°	-6°	SNGN 1207..	1,400

Riferimento Referencia							Nm
PSC40-CSRNR/L22050-12-4	1766	ISSN-442	9414	2713	1086	5003	3.0
PSC40-CSRNR/L22050-12-7	1766	ISSN-422	9414	2713	1086	5003	3.0
PSC50-CSRNR/L27060-12-4	1766	ISSN-442	9414	2713	1086	5003	3.0
PSC50-CSRNR/L27060-12-7	1766	ISSN-422	9414	2713	1086	5003	3.0
PSC63-CSRNR/L35065-12-4	1766	ISSN-442	9414	2713	1086	5003	3.0
PSC63-CSRNR/L35065-12-7	1766	ISSN-422	9414	2713	1086	5003	3.0

### SNGN

Inserto quadrato negativo.  
Plaquita cuadrada negativa. D05

Riferimento / Ref.	l	s	d
SNGN 1204..	12,70	4,76	12,70
SNGN 1207..	12,70	7,94	12,70

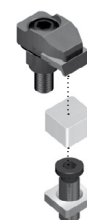
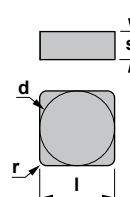

### SNGN





**Caratteristiche:**

Portautensili per applicazioni esterne di tornitura e spallamento, montano inserti quadrati negativi. PSC con refrigerazione interna.

- 1)  $\gamma$  = Angolo di spoglia (valido con un inserto piano).
- 2)  $\lambda_s$  = Angolo d'inclinazione.

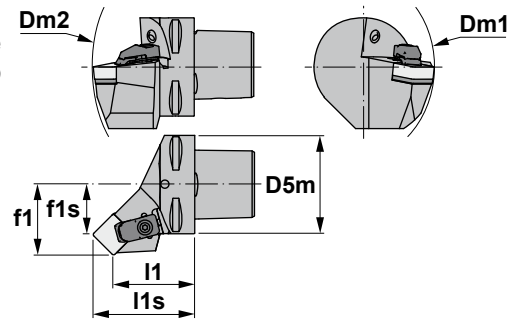

**Características:**

Portaherramientas para aplicaciones de torneado exterior y achaflanado equipado con plaquita cuadrada negativa. PSC con refrigeración interior.

- 1)  $\gamma$  = Ángulo de desprendimiento (válido para plaquitas planas).
- 2)  $\lambda_s$  = Ángulo de inclinación.

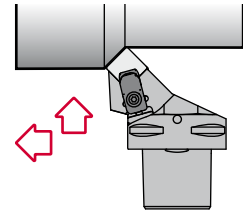

## CSSN 45°

Riferimento Referencia	D5m	Dm1 min.	Dm2 min.	f1	f1s	l1	l1s	$\gamma^1$	$\lambda_s^2$	Dimensioni inserto Medida plaquita	Kg
PSC40-CSSNR/L27042-12-4	40	110	140	27	18.7	42	50.3	-8°	-0°	SNGN 1204..	0,350
PSC40-CSSNR/L27042-12-7	40	110	140	27	18.7	42	50.3	-8°	-0°	SNGN 1207..	0,350
PSC50-CSSNR/L35052-12-4	50	110	165	35	26.7	52	60.3	-8°	-0°	SNGN 1204..	0,700
PSC50-CSSNR/L35052-12-7	50	110	165	35	26.7	52	60.3	-8°	-0°	SNGN 1207..	0,700
PSC63-CSSNR/L45056-12-4	63	110	190	45	36.7	56	64.3	-8°	-0°	SNGN 1204..	1,120
PSC63-CSSNR/L45056-12-7	63	110	190	45	36.7	56	64.3	-8°	-0°	SNGN 1207..	1,120

Riferimento Referencia							Nm
PSC40-CSSNR/L27042-12-4	1766	ISSN-442	9414	2713	1086	5003	3.0
PSC40-CSSNR/L27042-12-7	1766	ISSN-422	9414	2713	1086	5003	3.0
PSC50-CSSNR/L35052-12-4	1766	ISSN-442	9414	2713	1086	5003	3.0
PSC50-CSSNR/L35052-12-7	1766	ISSN-422	9414	2713	1086	5003	3.0
PSC63-CSSNR/L45056-12-4	1766	ISSN-442	9414	2713	1086	5003	3.0
PSC63-CSSNR/L45056-12-7	1766	ISSN-422	9414	2713	1086	5003	3.0

### SNGN

Inserto quadrato negativo.  
Plaquita cuadrada negativa. D05

Riferimento / Ref.	l	s	d
SNGN 1204..	12,70	4,76	12,70
SNGN 1207..	12,70	7,94	12,70

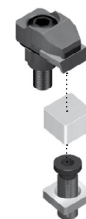
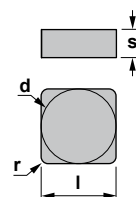

### SNGN



